

ANDALE MICRO MATIC

DISPENSE EQUIPMENT 2023



DEDICATED TO
DRAUGHT QUALITY

DEDICATED TO DRAUGHT QUALITY

Andale Micro Matic have been manufacturing beer dispensing equipment since 1947. From humble beginnings in a small factory in the Victorian suburb of Brunswick, to a national company with outlets in Brisbane, Adelaide, Sydney, Somersby (N.S.W.) and Melbourne, Andale have grown to become Australia's largest manufacturer, supplier and installer of beer dispensing equipment.

The team at Andale Micro Matic are passionate about what they do and this is displayed in the products produced. Our philosophy wherever possible is to manufacture everything in-house to meet Andale's strict quality guidelines.

A further extension of this philosophy is Andale employing our own staff to install our Australian made beer dispensing systems. This helps to maintain the high quality standards that have become Andale's trademark within the industry.

At Andale, we believe the integrity of the product dispensed through our equipment must not be compromised, to provide a beer that is presented as the brewer intended. Cold, clean and fresh

History has shown that Andale Micro Matic's innovative design and manufacture of beer dispensing equipment has been at the cutting edge of the industry and helped to enlighten customer's awareness of the delights of tap beer.

Andale Micro Matic - A Passion for Tap Beer

To compliment our range of high quality beer dispensing equipment, Andale Micro Matic stock the following high quality brands;

- Micromatic dispensing equipment
- Valpar tubing
- Bevco Beer Coolers
- ITT Flojet pumps and accessories
- Oetiker Clamps
- Armacell insulation
- Grundfos Pumps
-

TABLE OF CONTENTS

1. TAPS AND FONT ADAPTORS.....	5
2. FONTS AND DRIP TRAYS	11
3. SNAPLOK EQUIPMENT	49
4. PINVALVE AND LINEVALVE.....	55
5. COOLROOM EQUIPMENT	59
6. CLEANING PRODUCTS.....	67
7. KEG COUPLERS	75
8. GAS EQUIPMENT	81
9. GLYCOL EQUIPMENT	89
10. ICE BANK CHILLERS	95
11. MOBILE BARS AND PORTABLE EQUIPMENT	99
12. FLEXIDRAFT	107
13. TUBING & PYTHON.....	117
14. ACCESSORIES AND FITTINGS	127



ANDALE MICRO MATIC

TAPS AND FONT ADAPTORS



BRUMBY TAP

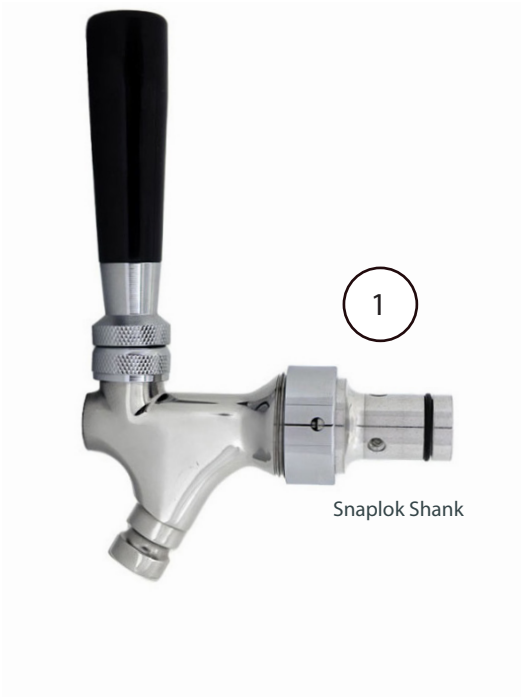

Snaplok Shank

Product Code	No.	Description	Finish
00050121	1	BRUMBY TAP FLUSHOUT SNAPLOK	S/S
00050111		BRUMBY TAP - STOUT	S/S
00050421		BRUMBY TAP FLUSHOUT 3/8" BSP F	S/S
00050721		BRUMBY TAP FLUSHOUT LOCK-IN	S/S
00052812 (Z000540)		BRUMBY STOUT RESTRICTOR	
088028		BRUMBY TAP BRUSH PLUG	
0005342		BRUMBY SHANK-3/8" BSP FEMALE	S/S
0005343		BRUMBY SHANK-PUSHLOK	S/S
0005346		BRUMBY SHANK-5/8" BSP x 4-6mm	S/S
0005347		BRUMBY SHANK-DISCONNECT	S/S
0005350		BRUMBY SHANK-FLOW RESTRICTOR	S/S

OPTIONS

3/8" BSP Female Shank



Pushlock Shank



3/4" BSP Shank



5/8" BSP Shank



Brumby Flow Restrictor Shank



Threaded nozzle fitted with stout restrictor



Brumby Tap Brush Plug



Growler Extension

BRUMBY TAP - PARTS

Product Code	No.	Description	Finish
00052100	1	BRUMBY HANDLE	
	2	HANDLE SPINDLE BONNET	CHROME
BS111	3	BS111 'O' RING	
0005271	4	BALL WASHER	
0005220	5	HANDLE SPINDLE	S/S
0005221		HANDLE SPINDLE+12mm	S/S
	6	BRUMBY BODY-FLUSHOUT	S/S
		BRUMBY BODY-GUINNESS	S/S
000529	7	SPINDLE	
0005342		BACK POUR SPINDLE	
0005343		BACK POUR SPINDLE WASHER	
0005346		BACK POUR SPINDLE NUT	
0005347		BACK POUR SPINDLE SPRING	
BS011	8	BS011 'O' RING	
000530	9	VALVE SEAT	
BS018	10	BS018 'O' RING	
0005340	11	BRUMBY SHANK-SNAPLOK	S/S
0005331	13	SHANK NUT	S/S
088018	14	BRUMBY "C" SPANNER	
098241	15	BRUMBY TAP KIT	
BS014	12	SNAPLOK SHANK 'O' RING	
BS111		PUSHLOCK SHANK 'O' RING	

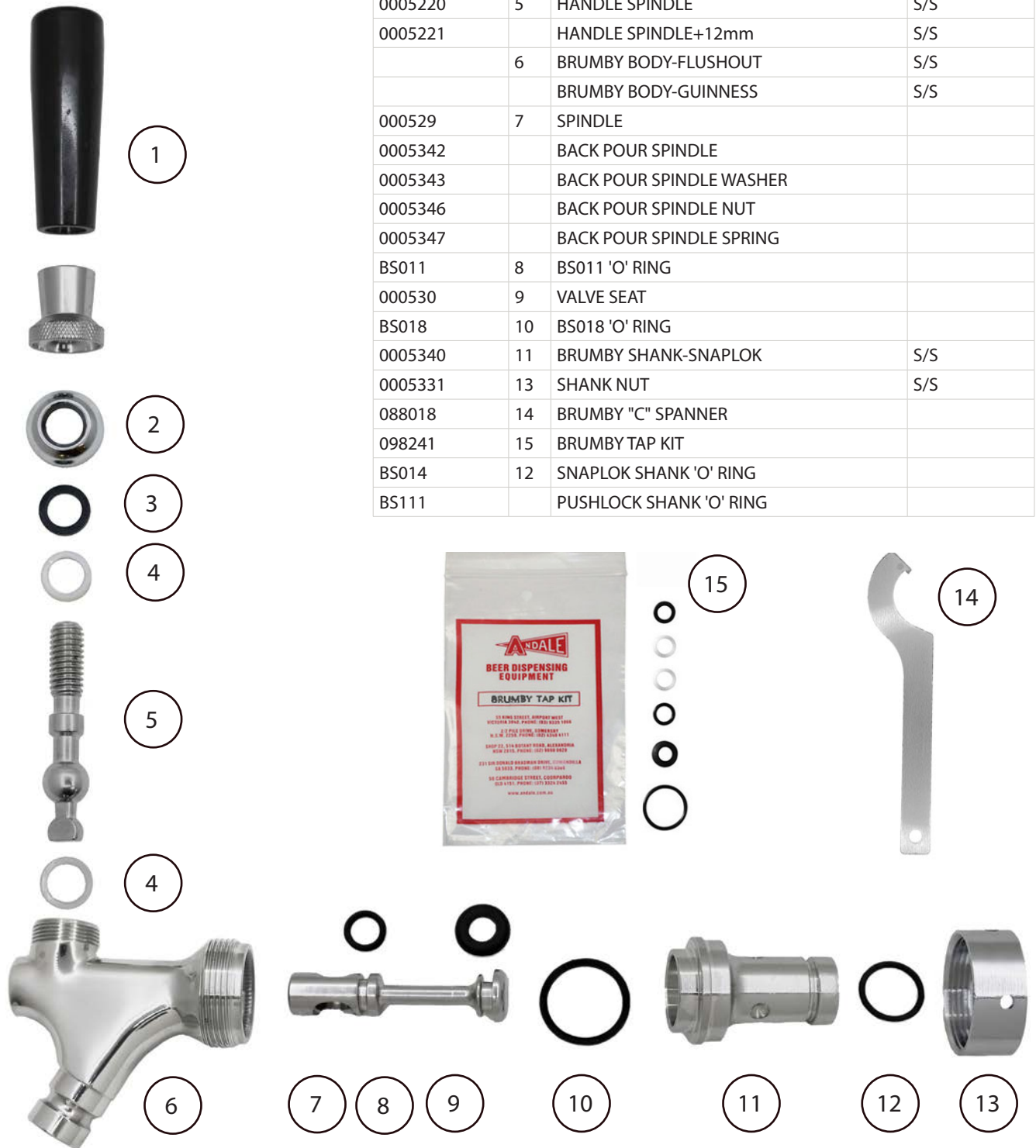

FONT AND TAP ACCESSORIES



73mm Decal Holder

AVAILABLE IN

- Chrome, Copper, Antique Bronze and Black Sapphire
- Small (32mm. Fits onto Brumby Tap Ring)
- Medium (35mm. Fits onto Snaplok Adaptor)
- Large (42mm. Fits onto Font Ring)



Decal Holder - serving side

AVAILABLE IN

- Chrome, Copper, Antique Bronze and Black Sapphire
- Large (42mm. Fits onto Font Ring)



Decal Holder Allen Key



Fitted Decal Holder
(Branding not provided)

Plastic Handle to suit
Brumby tap
Available in Black



Ceramic tap handle to suit
Brumby tap, DA or Floryte
taps
Available in Black or White







ANDALE MICRO MATIC

FONTS AND DRIP TRAYS



100% AUSTRALIAN MADE SINCE 1947



DEDICATED TO DRAUGHT QUALITY

Andale Micro Matic's range of beer dispensing equipment is 100% Australian made. After sourcing the highest quality raw materials, Andale uses a state of the art CNC engineering workshop to design and manufacture our range of beer dispensing equipment.

From machining, welding, polishing, electroplating, assembly and testing every Andale Micro Matic product is proudly made in Australia.

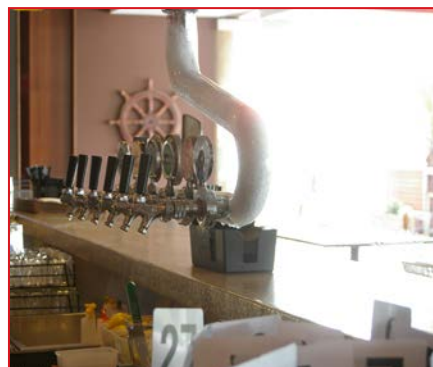

FINISHES

Andale Micro Matic's range of beer fonts are available in a wide range of decorative finishes. As Andale Micro Matic manufacture all of our beer fonts in-house and have our own electroplating division, we have the flexibility to supply a comprehensive range of finishes.

Andale Micro Matic can also produce fonts with a powder coated finish in a range of Dulux colours giving you the choice to install a beer font in a custom finish. *(* Finishes are part of the Premium Range)*



Chrome



Gold*



Copper



Satin Nickel



Antique Bronze
Dark



Antique Bronze
Light



Black Sapphire
Polished*



Black Sapphire
Brushed*



Powder Coat
Black



Powder Coat
White



Aged Brass
Polished



Aged Brass
Brushed

THE ANDALE FONT



11.5" (290mm)

15" (377mm)



Double Font

AVAILABLE IN

- Full range of finishes
- Flooded / Unflooded format
- 1 to 6 tap
- 11.5" (290mm) or 15" (377mm) standard heights
- 50mm upright, 76mm base
- 4mm or 5mm riser lines
- 100% Australian Made



Chrome Finish



Gold Finish



Fonts pictured with optional fitted decal holders



Antique Bronze Finish



Black Sapphire - Brushed Finish



FONTS AND DRIP TRAYS

THE BIG T FONT



AVAILABLE IN

- Full range of finishes
- Flooded / Unflooded format
- 2 to 8 tap
- 380mm standard height
- 76mm upright
- 4mm or 5mm riser lines
- 100% Australian Made



FONTS AND DRIP TRAYS

THE FEDERATION FONT



AVAILABLE IN

- Full range of finishes
- Black , white, burgandy and green ceramic bases available
- Flooded / Unflooded format
- 1 to 6 tap
- 380mm standard height
- 76mm upright, 152mm base
- 4mm or 5mm riser lines
- 100% Australian Made



FONTS AND DRIP TRAYS

THE LUCKY 7 FONT



Standard pictured



AVAILABLE IN

- Full range of finishes
- Flooded / Unflooded format
- 2 to 6 tap
- 380mm standard height
- 50mm upright, 76mm base
- 4mm or 5mm riser lines
- Standard and reverse configuration available
- 100% Australian Made

FONTS AND DRIP TRAYS

THE KALGOORLIE FONT



AVAILABLE IN

- Full range of finishes
- Flooded / Unflooded format
- 1 to 6 tap
- 380mm standard height
- 50mm upright, 76mm base
- 4mm or 5mm riser lines
- 100% Australian Made

FONTS AND DRIP TRAYS

THE REGENT FONT



AVAILABLE IN

- Full range of finishes
- Flooded / Unflooded format
- 1 to 6 tap
- 380mm standard height
- 50mm upright, 76mm base
- 4mm or 5mm riser lines
- 100% Australian Made

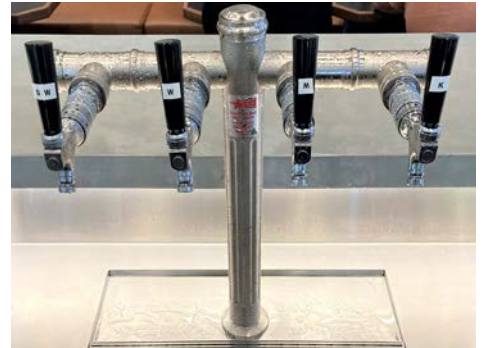

FONTS AND DRIP TRAYS

THE REGATTA FONT



AVAILABLE IN

- Full range of finishes
- Flooded / Unflooded format
- 2 to 10 tap
- 380mm standard height
- 76mm upright
- 4mm or 5mm riser lines
- 100% Australian Made



FONTS AND DRIP TRAYS

THE 48 DEGREE FONT



AVAILABLE IN

- Full range of finishes
- Flooded / Unflooded format
- 1 tap
- 380mm standard height
- 64mm base
- 4mm or 5mm riser lines
- 100% Australian Made

FONTS AND DRIP TRAYS

THE GUNN FONT



AVAILABLE IN

- Full range of finishes
- Flooded / Unflooded format
- 1 tap
- 380mm standard height
- 4mm or 5mm riser lines
- 100% Australian Made

FONTS AND DRIP TRAYS

THE TAIPAN FONT



AVAILABLE IN

- Full range of finishes
- Flooded / Unflooded format
- 1 to 4 tap
- 380mm standard height
- 4mm or 5mm riser lines
- 100% Australian Made

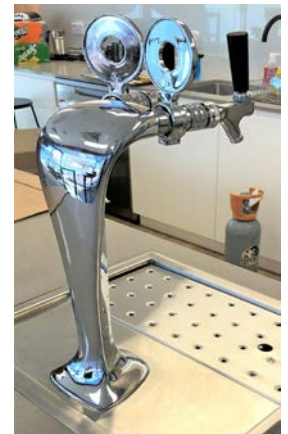

FONTS AND DRIP TRAYS

THE FAN FONT



AVAILABLE IN

- Full range of finishes
- Flooded / Unflooded format
- 2 to 8 tap
- 380mm standard height
- 4mm or 5mm riser lines
- 100% Australian Made



FONTS AND DRIP TRAYS

THE VISION FONT



FONTS AND DRIP TRAYS

THE MULTI VISION FONT



AVAILABLE IN

- Full range of finishes
- Beer viewing chamber with chilling tube.
- Vent under font
- 380mm standard height
- Exclusive to Andale Micro Matic
- 100% Australian Made

FONTS AND DRIP TRAYS

THE FLANGED VISION FONT



FONTS AND DRIP TRAYS

THE KETTLE FONT



AVAILABLE IN

- Full range of finishes
- Flooded / Unflooded format
- 2 to 12 tap
- 455mm standard height
- 76mm tube, 240mm base
- 4mm or 5mm riser lines
- 100% Australian Made



FONTS AND DRIP TRAYS

THE FLANGED FONT



AVAILABLE IN

- Full range of finishes
- Flooded / Unflooded format
- 2 to 20 tap
- 380mm standard height
- 76mm upright, 115mm base
- 4mm or 5mm riser lines
- 100% Australian Made



FONTS AND DRIP TRAYS

THE RA FLANGED FONT



AVAILABLE IN

- Full range of finishes
- Flooded / Unflooded format
- 2 to 6 tap
- 380mm standard height
- 4mm or 5mm riser lines
- 100% Australian Made

Reverse pictured

FONTS AND DRIP TRAYS

THE T FLANGED FONT



AVAILABLE IN

- Full range of finishes
- Flooded / Unflooded format
- 1 to 12 tap
- 380mm standard height
- 76mm upright, 115mm base
- 4mm or 5mm riser lines
- 100% Australian Made



FONTS AND DRIP TRAYS

THE T FLANGED FONT DOUBLE LEG



AVAILABLE IN

- Full range of finishes
- Flooded / Unflooded format
- 10 to 24 tap
- 380mm standard height
- 38mm upright, 44mm base
- 4mm or 5mm riser lines
- 100% Australian Made

FONTS AND DRIP TRAYS

THE HARBOUR FONT



AVAILABLE IN

- Full range of finishes
- Flooded / Unflooded format
- 2 to 12 tap
- 455mm standard height
- 76mm upright
- 4mm or 5mm riser lines
- 100% Australian Made



FONTS AND DRIP TRAYS

THE WESTGATE FONT



AVAILABLE IN

- Full range of finishes
- Flooded / Unflooded format
- 8 to 16 tap
- 380mm standard height
- 76mm tube
- 4mm or 5mm riser lines
- 100% Australian Made

FONTS AND DRIP TRAYS

THE APOLLO FONT



AVAILABLE IN

- Full range of finishes
- Flooded / Unflooded format
- 4 to 16 tap
- 380mm standard height
- 76mm upright
- 4mm or 5mm riser lines
- 100% Australian Made



FONTS AND DRIP TRAYS

THE RA APOLLO FONT



AVAILABLE IN

- Full range of finishes
- Flooded / Unflooded format
- 2 to 4 tap
- 380mm standard height
- 76mm upright
- 4mm or 5mm riser lines
- 100% Australian Made

FONTS AND DRIP TRAYS

THE SETTE FONT



AVAILABLE IN

- Full range of finishes
- Flooded / Unflooded format
- 2 to 6 tap
- 380mm standard height
- 76mm upright
- 4mm or 5mm riser lines
- 100% Australian Made

FONTS AND DRIP TRAYS

THE DOUBLE SETTE FONT



AVAILABLE IN

- Full range of finishes
- Flooded / Unflooded format
- 2 to 12 tap
- 380mm standard height
- 76mm tube
- 4mm or 5mm riser lines
- 100% Australian Made

FONTS AND DRIP TRAYS

THE DOUBLE T FONT



AVAILABLE IN

- Full range of finishes
- Flooded / Unflooded format
- 4 to 12 tap
- 280mm lower and 500mm upper standard height
- 76mm upright, 115mm base
- 4mm or 5mm riser lines
- 100% Australian Made



FONTS AND DRIP TRAYS

THE DOUBLE STOREY FONT



AVAILABLE IN

- Full range of finishes
- Flooded / Unflooded format
- 4 to 24 tap
- 280mm lower and 500mm upper standard height
- 76mm tube, 115mm base
- 4mm or 5mm riser lines
- 100% Australian Made



THE SKINNY FONT



AVAILABLE IN

- Full range of finishes
- Flooded / Unflooded format
- 1 tap
- 380mm standard height
- 25mm upright, 64mm base
- 4mm or 5mm riser lines
- 100% Australian Made



THE DOUBLE SKINNY FONT

AVAILABLE IN

- Full range of finishes
- Flooded / Unflooded format
- 2 tap
- 600 mm standard height
- 25mm tube, 64mm base
- Round decal holders standard
- Custom Decal holders (option)
- 4mm or 5mm riser lines
- 100% Australian Made



FONTS AND DRIP TRAYS

THE OLYMPIC FONT



AVAILABLE IN

- Full range of finishes
- Flooded / Unflooded format
- 1 tap
- Comes with decal holder
- 600mm standard height
- 400mm tap centre
- 50mm upright, 76mm base
- 4mm or 5mm riser lines
- 100% Australian Made

FONTS AND DRIP TRAYS

THE CRICKET FONT



AVAILABLE IN

- Full range of finishes
- Flooded / Unflooded format
- 1 to 3 tap
- 380mm standard height
- 38mm upright, 44mm base
- 4mm or 5mm riser lines
- 100% Australian Made

THE INSULATED FONT



Single illuminated version featured

AVAILABLE IN

- Full range of finishes
- Flooded / Fully Insulated
- 1 to 6 tap
- 380mm standard height
- 101mm tube
- 5mm riser lines
- 100% Australian Made



ABOUT ANDALE MICRO MATIC'S INSULATED FONT

Andale Micro Matic's Insulated font is designed to reduce system loading and power consumption. The Insulated font features a fully flooded font with an insulated cover. The Insulated cover helps to eliminate condensation and ice formation. By insulating the font the required refrigeration loading is reduced, saving power and helping to provide a lower carbon footprint.



FONTS AND DRIP TRAYS

THE INSULATED FLANGED FONT

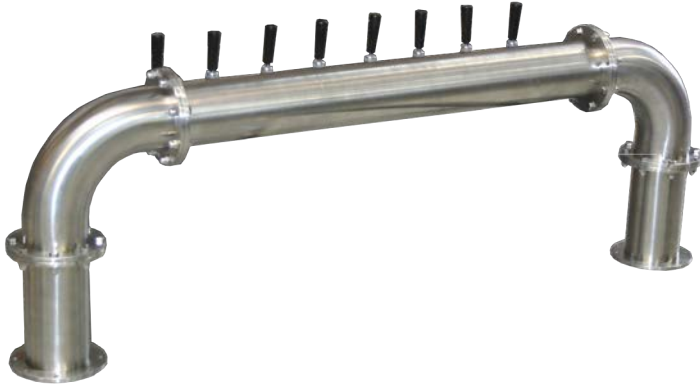

AVAILABLE IN

- Full range of finishes
- Flooded / Fully Insulated
- 2 to 12 tap
- 380mm tap centre
- 101mm upright, 150mm base
- 4mm or 5mm riser lines
- 100% Australian Made

FONTS AND DRIP TRAYS

THE INSULATED "T" FLANGED FONT



AVAILABLE IN

- Full range of finishes
- Flooded / Fully Insulated
- 2 to 8 tap
- 380mm tap centre
- 101mm upright, 150mm base
- 4mm or 5mm riser lines
- 100% Australian Made

FONTS AND DRIP TRAYS

THE INSULATED FLANGED FONT - WALL MOUNTED



AVAILABLE IN

- Full range of finishes
- Flooded / Fully Insulated format
- 2 to 12 tap
- 380mm tap centre
- 101mm upright, 150mm base
- 5mm riser lines
- 100% Australian Made

FONTS AND DRIP TRAYS

THE MILLHOUSE FONT



AVAILABLE IN

- Full range of finishes
- Flooded / Fully Insulated format
- 2 to 8 tap (Single upright)
- 8 to 18 tap (Double upright)
- 380mm standard height
- 4mm or 5mm riser lines
- 100% Australian Made

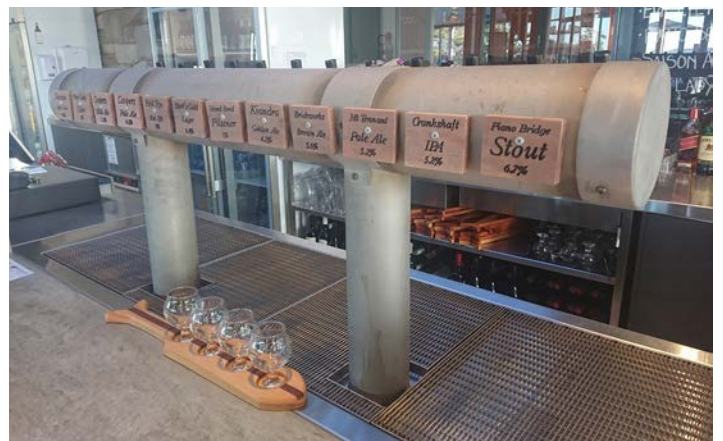

THE MATISSE FONT



AVAILABLE IN

- Full range of finishes
- Flooded / Unflooded format
- 2 to 8 tap (Single upright)
- 8 to 18 tap (Double upright)
- 380mm standard height
- 80mm upright
- 4mm or 5mm riser lines
- 100% Australian Made



THE WINE FONT



AVAILABLE IN

- Full range of finishes
- Flooded / Unflooded format
- 2 to 6 tap
- 380mm standard height
- 50mm tube, 76mm base
- LED illuminated lightbox
- 100% Australian Made
- Also available "BEER" Decal

FOUNTS AND DRIP TRAYS
THE MULTIPOUR



AVAILABLE IN

- Simple manual lever operation
- Easy change-over from 4 product dispense to 2 product dispense
- Easy installation
- Simple and cost effective maintenance (uses a standard Brumby tap kit)
- Dispenses 4 x 425ml beers in 7 seconds
- 100% Australian Made



FOUNTS AND DRIP TRAYS
THE MULTIPOUR C/W TROLLEY



AVAILABLE IN

- Simple manual lever operation
- Easy change-over from 4 product dispense to 2 product dispense
- Easy installation
- Simple and cost effective maintenance (uses a standard Brumby tap kit)
- Dispenses 4 x 425ml beers in 7 seconds
- 100% Australian Made

ANDALE MICRO MATIC

CUSTOM SOLUTIONS

DRAUGHT DESIGNS BROUGHT TO LIFE

INCREASE DRAUGHT BEER SALES

The beer font is not only a bar fixture, it is a marketing tool to help increase draught beer sales.

The various shapes, finishes and sizes of the draught beer font are designed to complement your decor and enhance the point of sale.

FONTS AND DRIP TRAYS

SEMI-DUAL TIER FONT



AVAILABLE IN

- Full range of finishes
- Flooded / Unflooded format
- 12 to 24 tap
- 300mm lower and 500mm upper standard height
- 76mm tube, 115mm base
- 4mm or 5mm riser lines
- 100% Australian Made



INSULATED FONTS



FONTS AND DRIP TRAYS

NEW YORK FONT

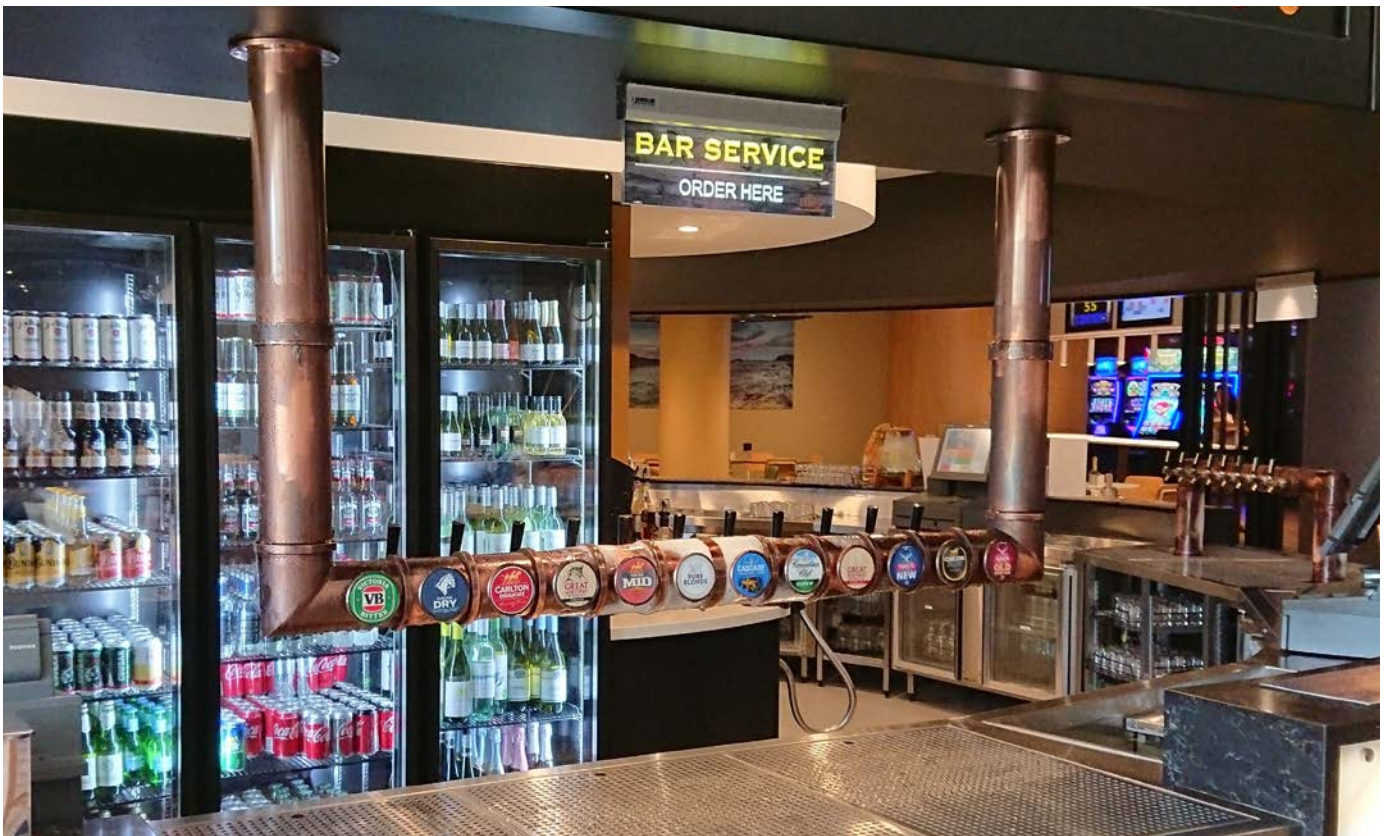
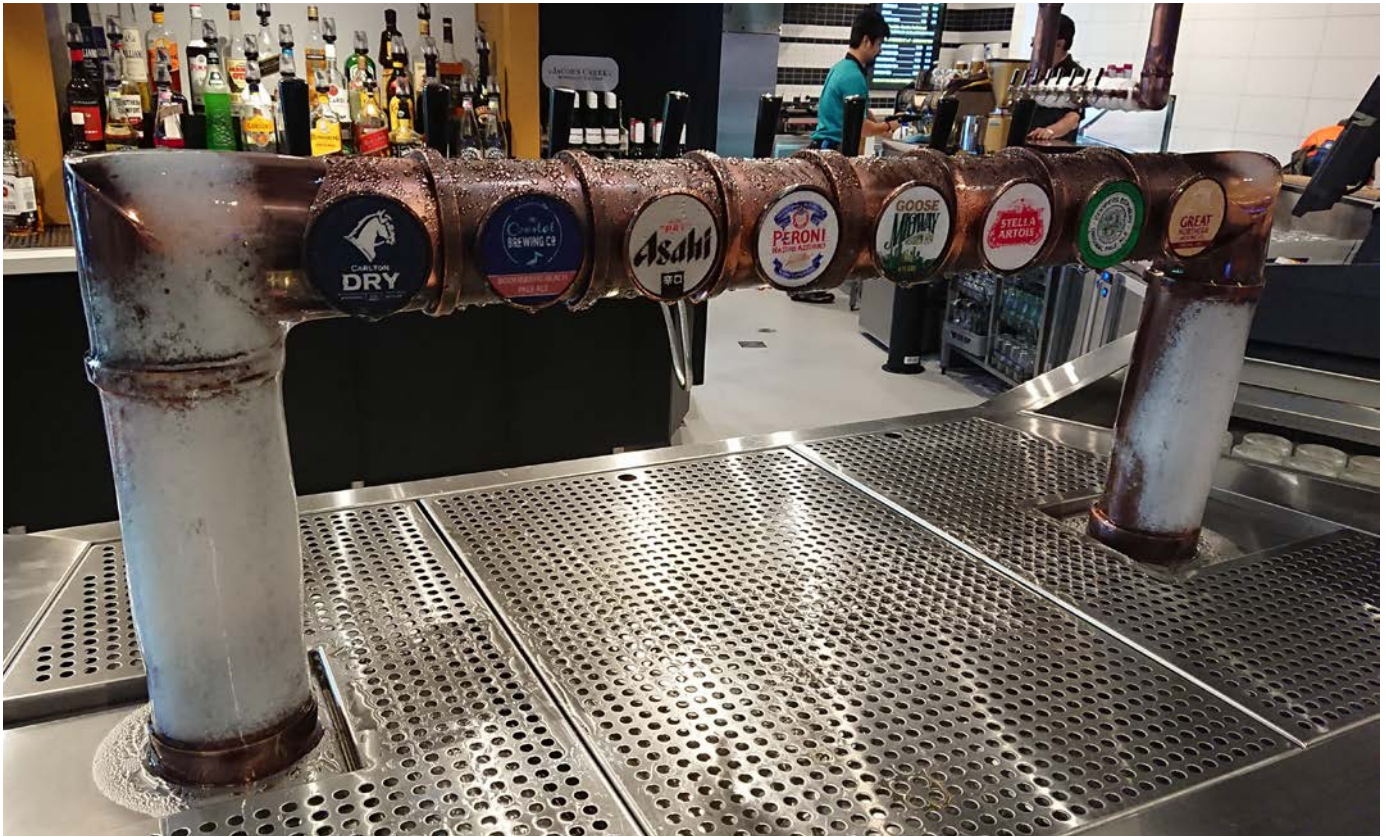

FONTS AND DRIP TRAYS

DOUBLE STOREY FLANGED FONTS



FONTS AND DRIP TRAYS

DOUBLE TIER FLANGED FONTS

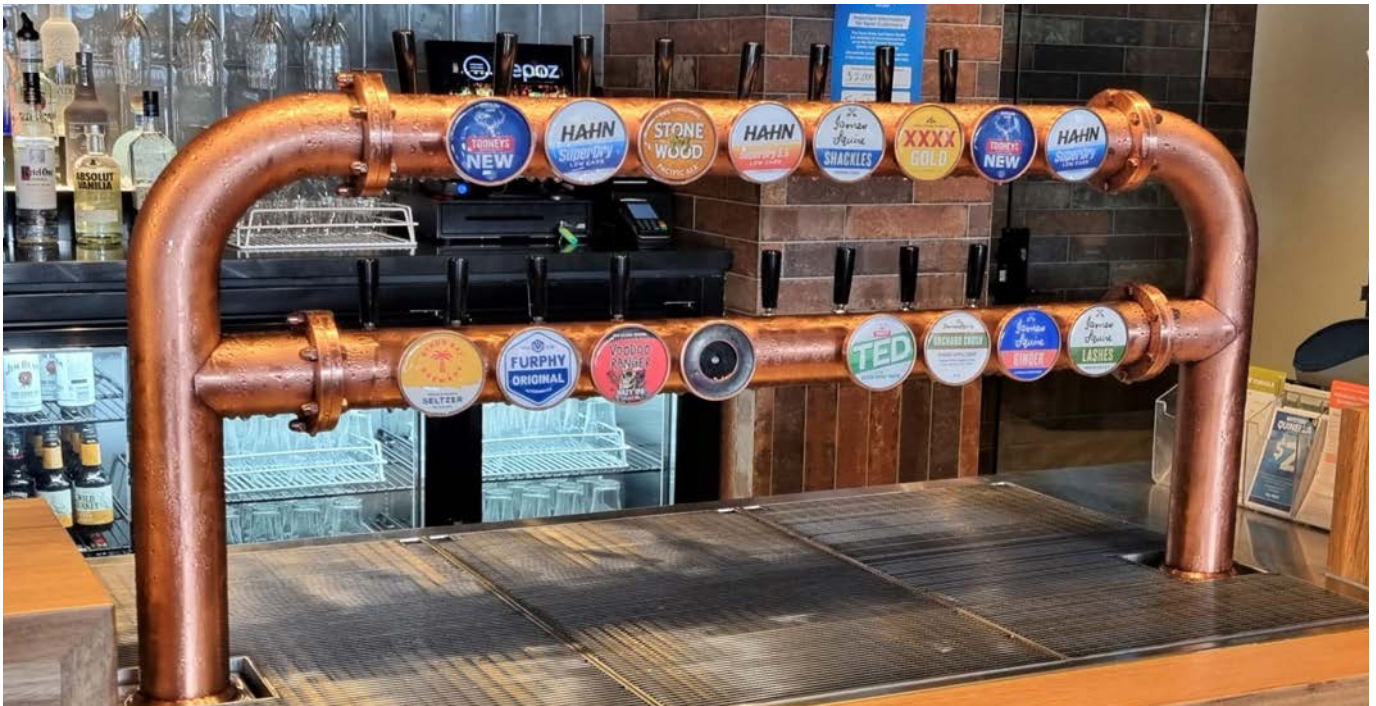

FONTS AND DRIP TRAYS
CUSTOM FONTS



FONTS AND DRIP TRAYS
CUSTOM FONTS

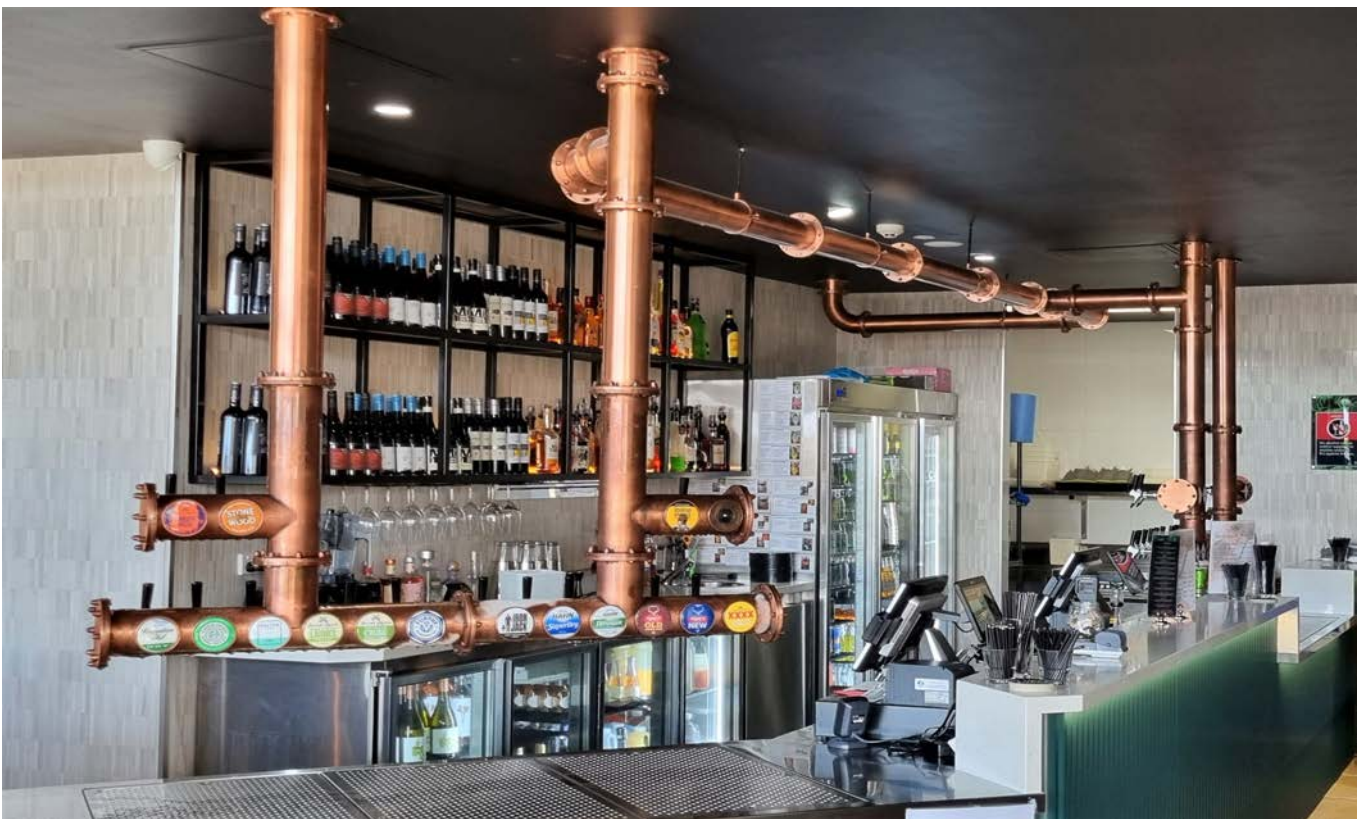

FONTS AND DRIP TRAYS
CUSTOM FONTS



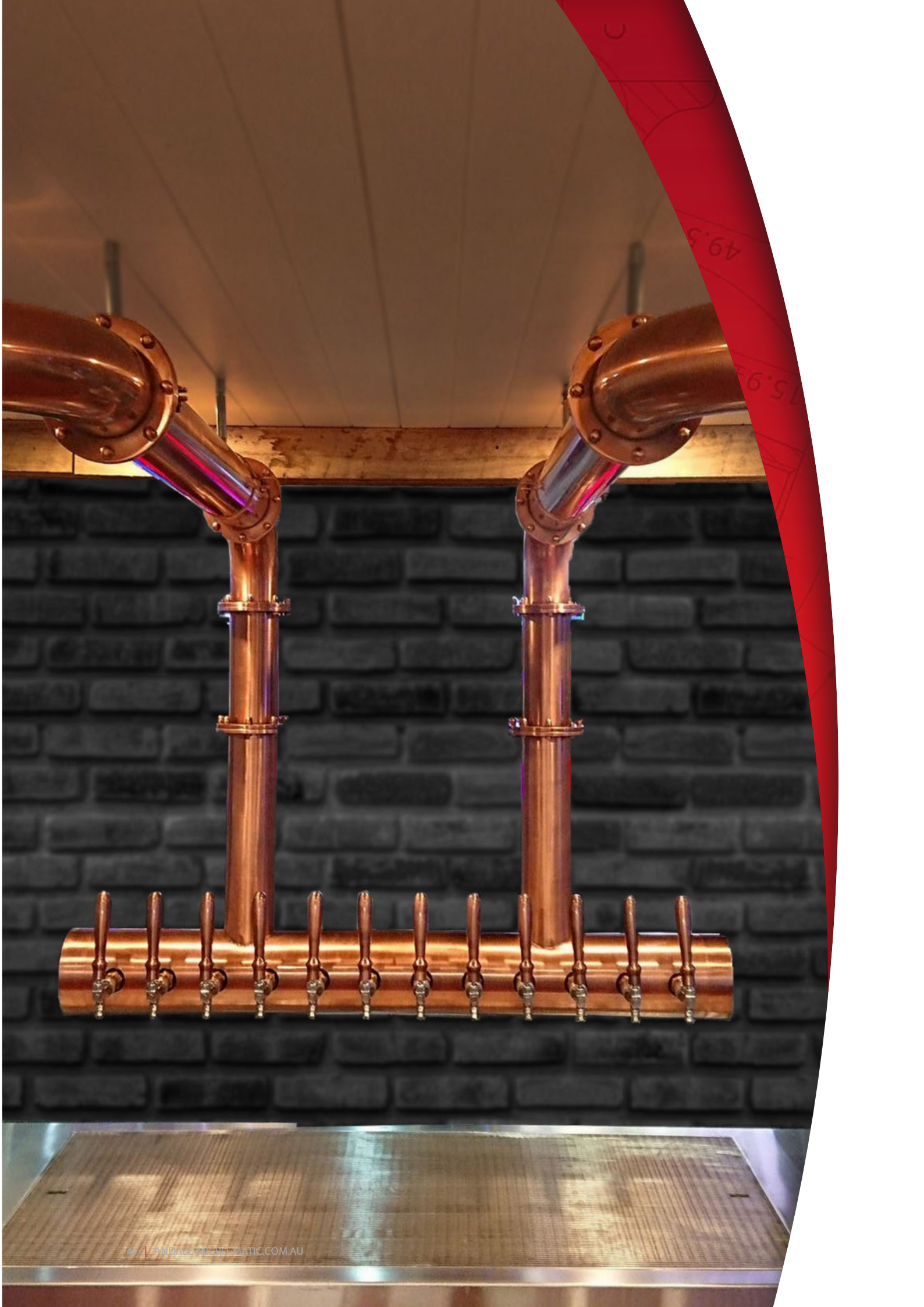

FONTS AND DRIP TRAYS

STANDARD DRIP TRAY



Product Code	Description	Finish
Z09614111	300mm x 180mm DRIP TRAY	S/S
Z09614113	400mm x 220mm DRIP TRAY	S/S
Z09614115	500mm x 180mm DRIP TRAY	S/S
Z09614118	800mm x 220mm DRIP TRAY	S/S

FONTS AND DRIP TRAYS

COUNTER INSERT DRIP TRAY



Product Code	Description	Finish
09680111	405mm x 350mm C/INSERT DRIP TRAY	S/S
09681111	550mm x 350mm C/INSERT DRIP TRAY	S/S
09683111	750mm x 350mm C/INSERT DRIP TRAY	S/S
09684111	900mm x 350mm C/INSERT DRIP TRAY	S/S
09685111	1100mm x 350mm C/INSERT DRIP TRAY	S/S
09686111	1300mm x 350mm C/INSERT DRIP TRAY	S/S
09687111	1500mm x 350mm C/INSERT DRIP TRAY	S/S



STANDARD FEATURES

- Inbuilt drain
- Catches condensation from flooded fonts
- Stainless Steel construction
- Custom sizes available
- 100% Australian Made

FONTS AND DRIP TRAYS

PLINTH DRIP TRAY



Product Code	Description	Finish
09671111	450mm x 350mm PLINTH DRIP TRAY	S/S
09671211	550mm x 350mm PLINTH DRIP TRAY	S/S
09671311	750mm x 350mm PLINTH DRIP TRAY	S/S
09671411	950mm x 350mm PLINTH DRIP TRAY	S/S
09671511	1100mm x 350mm PLINTH DRIP TRAY	S/S
09671611	1300mm x 350mm PLINTH DRIP TRAY	S/S
09671711	1500mm x 350mm PLINTH DRIP TRAY	S/S

STANDARD FEATURES

- Inbuilt drain
- Catches condensation from flooded fonts
- Stainless Steel construction
- Custom sizes available
- 100% Australian Made

FONTS AND DRIP TRAYS

PRESSED PLINTH DRIP TRAY



Product Code	Description	Finish
Z60304	250mm x 405mm BEVCO PLINTH DRIP TRAY	S/S
09690111	405mm x 350mm PRESSED PLINTH DRIP TRAY	S/S
09691111	520mm x 350mm PRESSED PLINTH DRIP TRAY	S/S

STANDARD FEATURES

- Inbuilt drain
- Catches condensation from flooded fonts
- Stainless Steel construction
- Custom sizes available
- 100% Australian Made

FONTS AND DRIP TRAYS

WATER SPRAY



Product Code	Description	Finish
Z097005 (096751)	WATER SPRAY HEAD	
Z097007	150mm x 150mm C/INSERT DRIP TRAY C/W WATER SPRAY	S/S

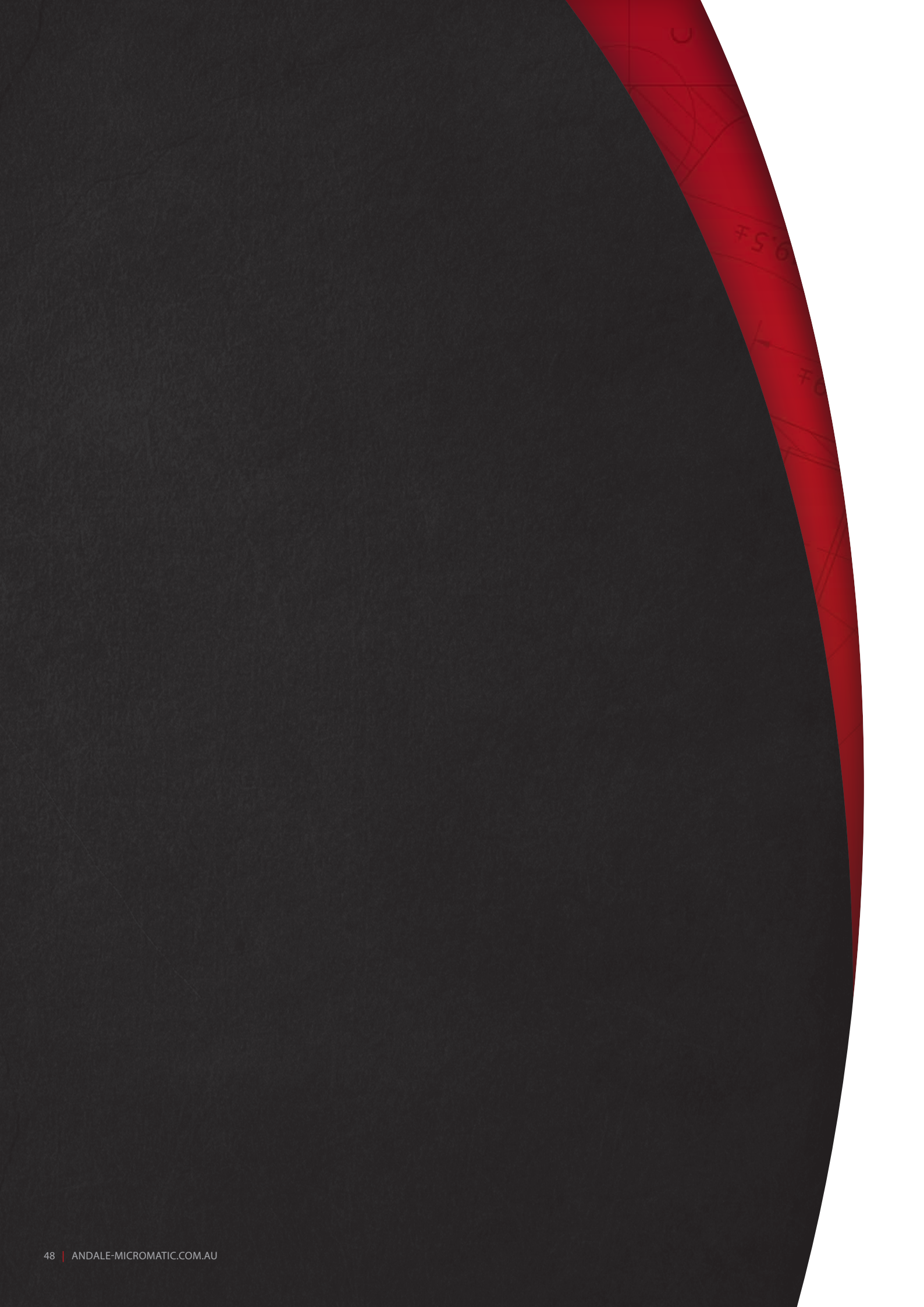

ANDALE MICRO MATIC

SNAPLOK EQUIPMENT

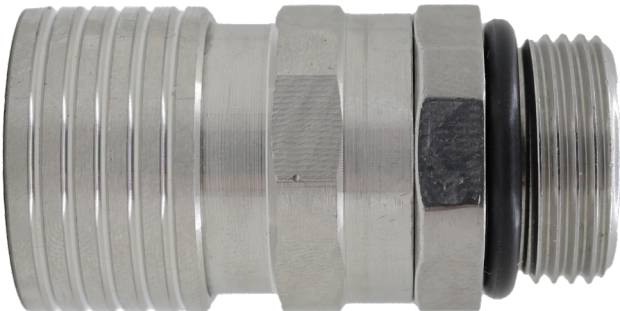

SNAPLOK ADAPTOR



3/4" Snaplok Adaptor

1

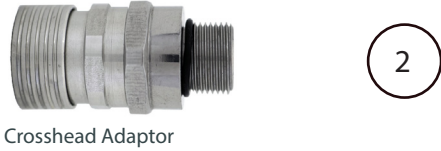

Crosshead Adaptor

2



5/8" Snaplok Adaptor

3

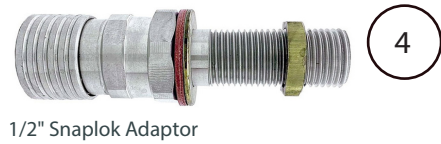

1/2" Snaplok Adaptor

4

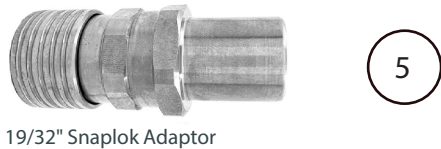

19/32" Snaplok Adaptor

5



1/2" BSPF Snaplok Adaptor

6



R/A Snaplok Adaptor

7

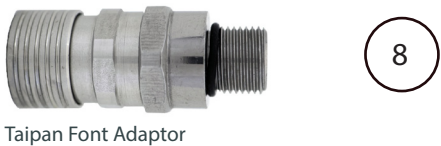

Taipan Font Adaptor

8



Homark Adaptor

9

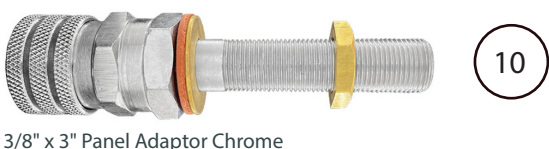

3/8" x 3" Panel Adaptor Chrome

10

Product Code	No.	Description	Finish
0020010		SNAPLOK ADAPTOR 3/4" BSP	GOLD
0020011	1	SNAPLOK ADAPTOR 3/4" BSP	S/S
002003	2	SNAPLOK CROSSHEAD ADAPTOR	S/S
002006	3	SNAPLOK ADAPTOR 5/8" BSPF	S/S
0020041	4	SNAPLOK PANEL ADAPTOR 1/2" BSP	S/S
002007	5	SNAPLOK ADAPTOR 19/32" BSP	S/S
002008	6	SNAPLOK ADAPTOR 1/2" BSPF	S/S
002010	7	SNAPLOK ELBOW ADAPTOR R/A	S/S
0020111		SNAPLOK CELLI ADAPTOR 5/8" BSP	S/S
0020130		SNAPLOK ADAPTOR TAIPAN FONT ARM	S/S
0020131	8	SNAPLOK ADAPTOR TAIPAN FONT ARM	S/S
002014	9	SNAPLOK ADAPTOR - HOMARK	S/S
002029	10	SNAPLOK PANEL ADAPTOR 3" x 3/8" BSP	CHROME

SNAPLOK ADAPTOR - PARTS



Product Code	No.	Description	Finish
002051		SL.1 CIRCLIP	
0020520		SL.2 RELEASE SLEEVE	GOLD
0020521		SL.2 RELEASE SLEEVE	CHROME
002053		SL.3 RELEASE SPRING	
002054		SL.4 BALLS	
0020550		SL.5 BODY	GOLD
0020551		SL.5 BODY	CHROME
002056		SL.6 RUBBER SEAL	
002057		SL.7 VALVE PLASTIC	
002059		SL.8 VALVE SPRING	
BS116		BS116 "O" RING	
0020610		SL.10 BACKNUT 3/4" BSP	GOLD
0020611		SL.10 BACKNUT 3/4" BSP	CHROME
Z098200		SNAPLOK KIT	



Snaplok Adaptor Kit

SNAPLOK ADAPTOR

SNAPLOK NOZZLE

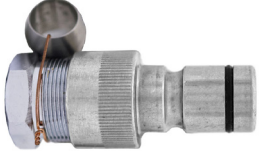

Product Code	No.	Description	Finish
014001		4MM SNAPLOK NOZZLE	S/S
014002	1	6MM SNAPLOK NOZZLE	S/S
014003	2	8MM SNAPLOK NOZZLE	S/S
014004	3	10MM SNAPLOK NOZZLE	S/S
014005	4	1/2" SNAPLOK NOZZLE	S/S

SNAPLOK BEERLINE CHECKVALVE

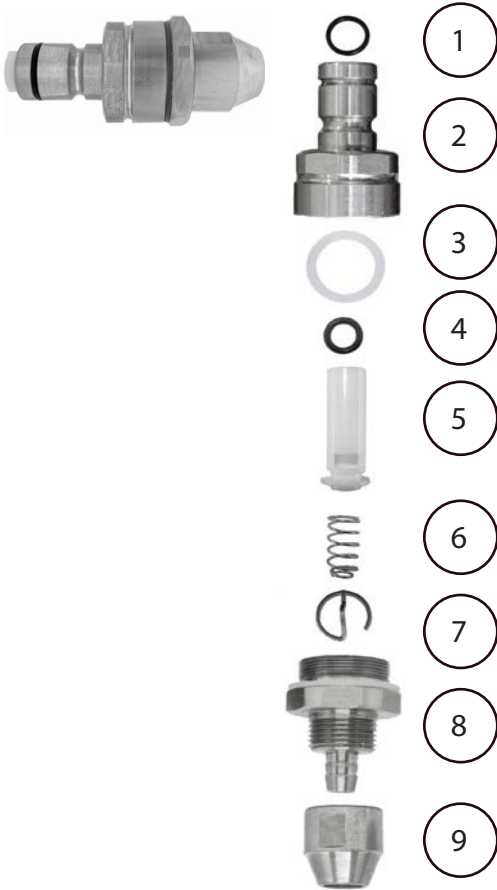

Product Code	No.	Description	Finish
012023		6MM SNAPLOK S/L BLCV BARBED	S/S
012025	8	8MM SNAPLOK S/L BLCV BARBED	S/S
012026		9.5MM SNAPLOK S/L BLCV BARBED	S/S
012027		10MM SNAPLOK S/L BLCV BARBED	S/S
012028		1/2" SNAPLOK S/L BLCV BARBED	S/S
012113		6MM BARBED CHECKVALVE NUT	S/S
012115	9	8MM BARBED CHECKVALVE NUT	S/S
012116		9.5MM BARBED CHECKVALVE NUT	S/S
012117		10MM BARBED CHECKVALVE NUT	S/S
012118		1/2" BARBED CHECKVALVE NUT	S/S
BS014	1	BS.014 "O" RING	
012071	2	CV.1A CHECKVALVE NOZZLE S/L	S/S
012075	3	CV.2 WASHER	
BS110	4	BS.110 "O" RING	
012078	5	CV.4A VALVE - S/L	S/S
012090	6	CV.5 SPRING	S/S
012091	7	CV.6 RETAINER	
012092		CV.7 4-6MM CHECKVALVE BODY	
012093		CV.7 8-10MM CHECKVALVE BODY	
012094		CV.7 1/2" CHECKVALVE BODY	

SNAPLOK GAS NOZZLE

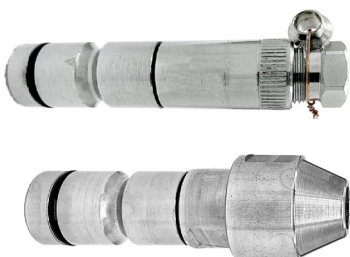

Product Code	No.	Description	Finish
026001		4MM SNAPLOK GAS NOZZLE	S/S
026002	1	6MM SNAPLOK GAS NOZZLE	S/S
026006	2	6MM SNAPLOK GAS NOZZLE - BARBED	S/S

SNAPLOK ADAPTOR

SNAPLOK MANIFOLD



Product Code	No.	Description	Finish
		See manifolds on page 60.	

SNAPLOK TRANSFER LEAD - 1.2M

Product Code	No.	Description	Finish
024004		10mm SNAPLOK S/L TRANSFER LEAD	S/S
024005		1/2" SNAPLOK S/L TRANSFER LEAD	S/S



SNAPLOK GAS NOZZLE

Product Code	No.	Description	Finish
020501		SNAPLOK PLUG-IN DOUBLE HEAD	S/S

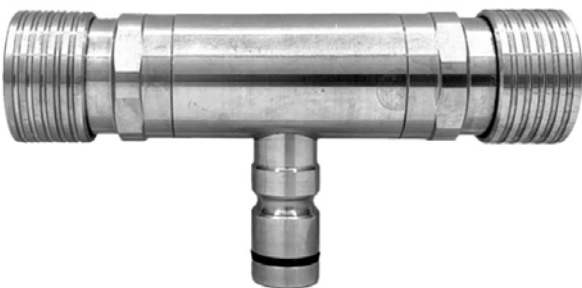

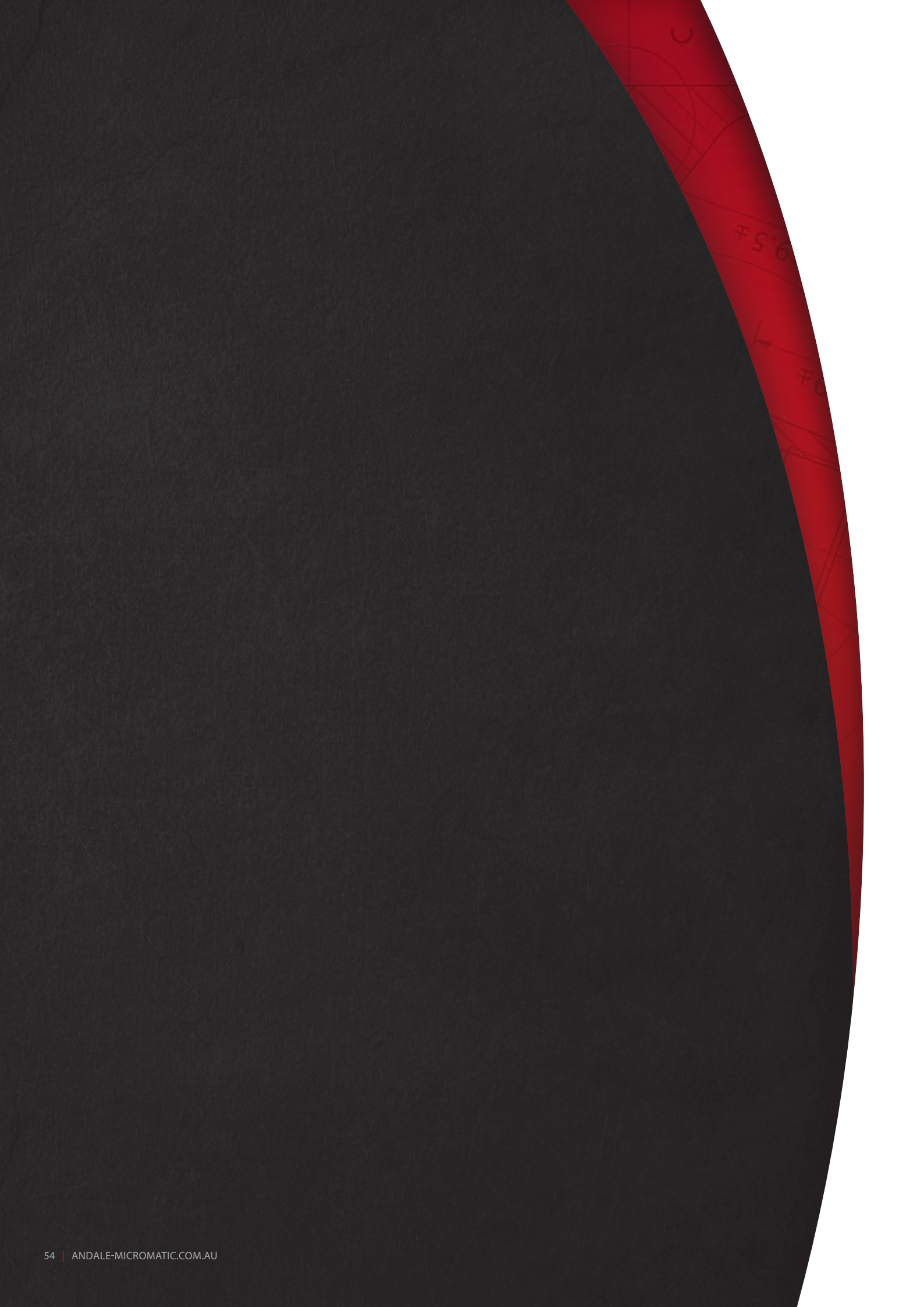

ANDALE MICRO MATIC

PINVALVE AND LINEVALVE EQUIPMENT

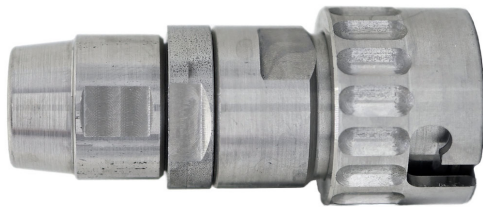

PINVALVE AND LINEVALVE

LINEVALVE



Product Code	No.	Description	Finish
012501		4mm LINEVALVE	S/S
012502		6mm LINEVALVE	S/S
012503		8mm LINEVALVE	S/S
012504		10mm LINEVALVE	S/S
012505		12.7mm LINEVALVE	S/S
012561	1	LINEVALVE CIRCLIP	
012562	2	LINEVALVE BAYONET RING	
012563	3	LINEVALVE NOZZLE	
BS109	4	BS109 "O" RING	
012566	5	LINEVALVE VALVE	
012567	6	LINEVALVE SPRING	
BS018	7	BS018 "O" RING	
012568		4-6mm LINE VALVE TAIL	
012569	8	8-10mm LINE VALVE TAIL	
012570		12.7mm LINE VALVE TAIL	
012113		6MM BARBED CHECKVALVE NUT	S/S
012115	9	8MM BARBED CHECKVALVE NUT	S/S
012116		9.5MM BARBED CHECKVALVE NUT	S/S
012117		10MM BARBED CHECKVALVE NUT	S/S
012118		1/2" BARBED CHECKVALVE NUT	S/S

PINVALVE



Product Code	No.	Description	Finish
002501		PINVALVE 3/4"BSP	S/S
002502		PINVALVE 5/8"BSP	S/S
BS113	1	BS.113 "O" RING	
002552	2	PINVALVE BODY 3/4" BSP	
002553		PINVALVE BODY 5/8" BSP	
BS109	3	BS.109 "O" RING	
012566	4	LINEVALVE VALVE	
012567	5	LINEVALVE SPRING	
012557	6	PINVALVE RETAINER	
012075	7	CV.2 WASHER	



Pinvalve Adaptor Kit - 5/8"

PINVALVE AND LINEVALVE EQUIPMENT

PINVALVE AND LINEVALVE

PINVALVE



Product Code	No.	Description	Finish
002501		PINVALVE 3/4" BSP	S/S
002502		PINVALVE 5/8" BSP	S/S

PINVALVE MANIFOLD



Product Code	No.	Description	Finish
		Please see manifolds on page 60.	

LINEVALVE TRANSFER LEAD - 1.2M

Product Code	No.	Description	Finish
024194		10mm LINEVALVE TRANSFER LEAD	S/S
024195		1/2" LINEVALVE TRANSFER LEAD	S/S



PINVALVE DOUBLE PLUG-IN HEAD

Product Code	No.	Description	Finish
020571		PINLOK PLUG-IN DOUBLE HEAD	S/S



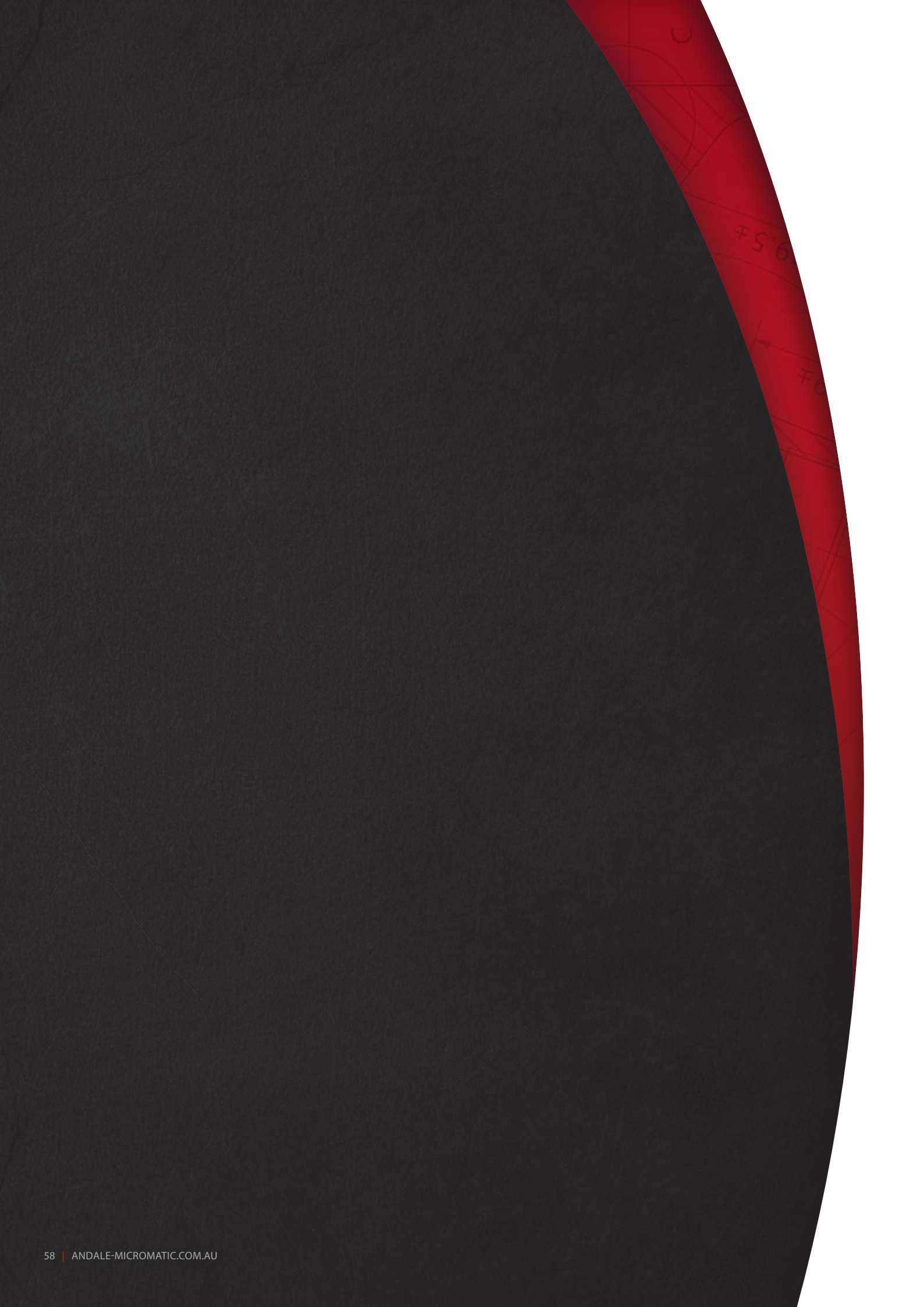

ANDALE MICRO MATIC

COOLROOM EQUIPMENT



COOLROOM EQUIPMENT

MANIFOLDS

SNAPLOK MANIFOLD



Product Code	No.	Description	Finish
016011		2 POINT SNAPLOK MANIFOLD	S/S
016012		3 POINT SNAPLOK MANIFOLD	S/S
016013		4 POINT SNAPLOK MANIFOLD	S/S
016014		5 POINT SNAPLOK MANIFOLD	S/S
016015		6 POINT SNAPLOK MANIFOLD	S/S
016016		7 POINT SNAPLOK MANIFOLD	S/S
016017		8 POINT SNAPLOK MANIFOLD	S/S

PINVALVE MANIFOLD



Product Code	No.	Description	Finish
016001		2 POINT UNIVERSAL MANIFOLD	S/S
016002		3 POINT UNIVERSAL MANIFOLD	S/S
016003		4 POINT UNIVERSAL MANIFOLD	S/S
016004		5 POINT UNIVERSAL MANIFOLD	S/S
002501		PINVALVE 3/4" BSP	S/S

MANIFOLD JOINER



Product Code	No.	Description	Finish
017503		MB.2 WASHER	
017504		MB.3 MANIFOLD BLANK PLUG	
017507		MB.5 MANIFOLD BRACKET	
017508		MB.6 MANIFOLD BRACKET PIN	
017511		MANIFOLD BLOCK JOINER BODY	S/S
017522		2-4 POINT MANIFOLD BLOCK	S/S
017523		3-5 POINT MANIFOLD BLOCK	S/S
017534		4-6 POINT MANIFOLD BLOCK	S/S
017525		5-7 POINT MANIFOLD BLOCK	S/S

MANIFOLD ADAPTOR



Product Code	No.	Description	Finish
017601		4mm MANIFOLD ADAPTOR	S/S
017602		6mm MANIFOLD ADAPTOR	S/S
017603		8mm MANIFOLD ADAPTOR	S/S
017604		10mm MANIFOLD ADAPTOR	S/S
017605		1/2" MANIFOLD ADAPTOR	S/S

MANIFOLD BARB - 1/2"



Product Code	No.	Description	Finish
0168690		1/2" BARBED NIPPLE	S/S

FOB MONITORS

STRONGMAN FOB MONITOR



Strongman fittings

Product Code	No.	Description	Finish
016704	1	STRONGMAN FOB MONITOR-9.5MM	
016714		STRONGMAN FOB MONITOR-9.5MM C/W MANIFOLD ADAPTOR	
016724	2	STRONGMAN FOB MONITOR-9.5MM HIGH FLOW	
016734		STRONGMAN FOB MONITOR-9.5MM C/W MANIFOLD ADAPTOR HIGH FLOW	
0167570		8mm DOME NUT	
0167510		BLEEDVALVE BUTTON	
0167530		BLEEDVALVE HOUSING	
0167550		5mm BARB	
BS107		BS.107 "O" RING	
0167520		BLEEDVALVE SPINDLE	
0167560		TOP PLATE	
016852		BLEEDVALVE SPRING	
BS014		BS.014 "O" RING	
0167540		BLEEDVALVE LOCKNUT	
BS008		BS.008 "O" RING	
0167610		PLASTIC TUBE	
BS137		BS.137 "O" RING	
0167580		8mm STUD	
0167590		OUTLET TUBE	
0167600		FLOAT	
BS112		BS.112 "O" RING	
0167620		FLOAT RESET SHAFT	
BS006		BS.006 "O" RING	
0167650		BASE PLATE	
0167630		RESET LEVER	
005529		1/8"BSW x 1/4" GRUB S/S SCREW	
BS012		BS.012 "O" RING	
0167637		6.3MM BARB	
0167639		8MM BARB	
0167640		9.5MM BARB	
0167641		12.7MM BARB	
0167651		BRACKET	
0167652		5mm SPRING WASHER	
0167653		5mm x 10mm S/S SCREW	
016700		STRONGMAN MANIFOLD ADAPTOR	
098371		STRONGMAN FOB KIT	
002016		SNAPLOK ADAPTOR-STRONGMAN	

FOB MONITORS

HOMARK FOB MONITOR



Product Code	No.	Description	Finish
HOM1000		HOMARK FOB DETECTOR C/W 1/2" TAIL	
HOM1009		10mm TAIL	
HOM1010		12.7mm TAIL	
HOM1020		O RING SERVICE KIT	
HOM1030		LOCK NUT	
HOM1031		MAIN LARGE O RING	
HOM1040		BALL FLOAT	
HOM1041		BALL FLOAT SEAL	
HOM1050		BLEED LEVER	
HOM1051		BLEED LEVER O RING	
HOM1052		ROLLED SPRING PIN	
HOM1053		1/4" x 5/16" JG ADAPTOR	
002014		SNAPLOK ADATOR-HOMARK	
JGPI011224S		1/2" x 3/8" JG ADAPTOR	



HOMARK SNAPLOK ADAPTOR

FOB MONITOR BRACKET SNAPLOK



Product Code	No.	Description	Finish
01678302		3/8" SNAPLOK F/MONITOR BRACKET	S/S
01687312		1/2" SNAPLOK F/MONITOR BRACKET	

BEER PUMPS AND ACCESSORIES

BEER PUMPS AND ACCESSORIES



G56 BEER PUMP



PUMP ELBOW



1/4" BARBED GAS TEE



STRONGMAN TO FLOJET ELBOW



T5000414 SYRUP PUMP



FLOJET C/O VALVE



50 LTR OILLESS AIR COMPRESSOR



AIR REGULATOR



SMC FILTER REGULATOR

Product Code	No.	Description	Finish
041001		FLOJET G56 BEER PUMP	
041026		1/4" BARBED GAS ELBOW - FLOJET	
041027		1/4" BARBED GAS TEE - FLOJET	
041044		9.5mm - 12.7mm ELBOW PUMP	
041100		FLOW REVERSAL VALVE FRV0001A FLOJET	
0167645		STRONGMAN TO FLOJET PUMP ELBOW	
Z041015		FLOJET T5000515 SYRUP PUMP	
Z041017		FLOJET C/O VALVE	
040152		30LTR OILLESS AIR COMPRESSOR - TWIN	
040153		100LTR OILLESS AIR COMPRESSOR - QUAD MOTOR	
040179		3 WAY FILTER BOARD C/W REGULATOR	
040180		3 WAY FILTER BOARD	
040011		AIRLINE REGULATOR 1/4" - AR200	
040161		SMC FILTER REGULATOR	

PANEL ADAPTORS AND DIRECT PULL

SNAPLOK 1/2" PANEL ADAPTOR

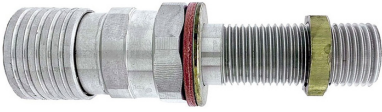

SNAPLOK 3" X 3/8" PANEL ADAPTOR

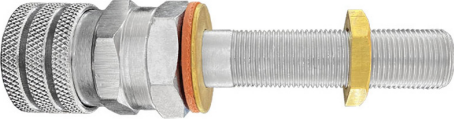

COOL ROOM PLATE

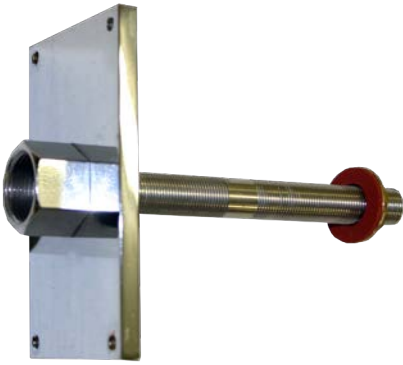

3/8" BSP X 6" NIPPLE



3/4" BSP X 3/8" PANEL NUT



INSULATED FLANGED TAP BOSS



Product Code	No.	Description	Finish
020041		SNAPLOK PANEL ADAPTOR 1/2" BSP	S/S
002029		SNAPLOK PANEL ADAPTOR 3" x 3/8" BSP	CHROME
007021		3/4" COOLROOM PLATE 6" x 3/8" BSP	CHROME
007051		3/4" BSP x 3/8" BSP PANEL NUT	S/S
007054		3/8" BSP x 6" NIPPLE	S/S
007521		INSULATED FLANGED TAP BOSS	CHROME

PANEL ADAPTORS AND DIRECT PULL





ANDALE MICRO MATIC

CLEANING PRODUCTS



A CLEAN GLASS PROMISES FRESH BEER TASTE!

BEER CLEAN GLASS RESULTS

- Enhanced aroma and taste.
- Retains a thick, creamy, foam head.
- Beer is sparkling clear and free of gas bubbles.
- Repeat business and added profits.

BEER CLEAN GLASS FACTS

- All glasses should be washed at least once a day.
- Odors and invisible film from smoke can occur in a matter of hours.
- Avoid dishwashing detergent. Surfactants and hand creaming additives will destroy a foam head.

GLASS WASHING TYPES

- For manual cleaning use at least two sinks for:
 1. Washing with glass washing detergent and suitable brush.
 2. Rinsing with pure fresh water.
- For machine washing: Follow the manufacturer's instructions. Never run glassware with pots, pans, dishes and food utensils.



CLEAN GLASS TEST: IS THE GLASS TRULY CLEAN?

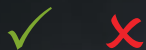

SHEETING TEST

Water sheets off glass without forming droplets.

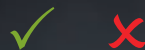

SALT TEST

Wet glass and shake salt into it. Anywhere there is a grease film the salt will not adhere.

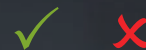

LACING TEST

Foam will adhere to the side of the glass after each drink creating rings or a "lacing" pattern. A random pattern will form in a dirty glass.



A dirty glass produces large coarse bubbles and a rapidly disappearing head. A clean glass will form a thick, creamy head and the beer will be clear of bubbles.

HEAD RETENTION

CROSSHEADS

BARBED SNAPLOK CROSSHEAD

Product Code	No.	Description	Finish
018031	4	1/2" UNIVERSAL TRUNK CROSSHEAD	
018033	3	1/2" SNAPLOK TRUNK CROSSHEAD	
018044	1	1/2" BARBED SNAPLOK CROSSHEAD	
018045	2	1/2" BARBED SNAPLOK CROSSHEAD BLANK	
018621	5	1/2" CROSSHEAD BLANK PLUG (WHITE)	
Z800600		12.7mm x 0.7mm 304 STAINLESS TUBE	



1



2



BARBED WASHOUT CROSS-HEAD FITTED WITH 3/4" PINVALVE



3



4



UNIVERSAL TRUNK CROSS-HEAD FITTED WITH 3/4" PINVALVE



5

1/2" CROSSHEAD BLANK PLUG

CLEANING PRODUCTS

BYPASS CUPS

BARBED WASHOUT CLEANING CUP

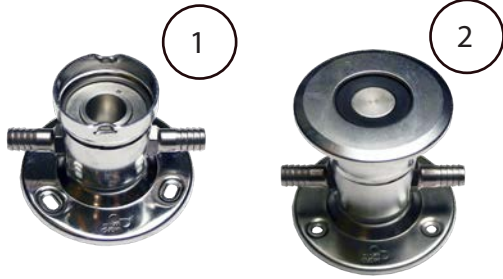

Product Code	No.	Description
018251	1	CLEANING CUP - WELL 2 x 10mm BARB
018252	2	CLEANING CUP - FLAT 2 x 10mm BARB

BYPASS CUPS



Product Code	No.	Description
018201		A53 BYPASS CUP - WELL
018202		A66 BYPASS CUP - FLAT
018211		A58 BYPASS CUP WALLMOUNT
018231		WALL MOUNT CLEANING CUP-WELL
018232		WALL MOUNT CLEANING CUP-FLAT

FITTINGS



Product Code	No.	Description
019002		NIPPLE HEX BRASS (1/2") 15mm
019010		FLEX HOSE 1/2" HEX (F/CONE) 300mm
019021		SYR PRV 100-500kpa 15mm RMC VALVE
019051		9.5mm CLIP-ON FLUSHOUT FITTING
019101		3/4"BSP x 5/8"C DETERGENT TUBE ADAPTOR

CLEANING PRODUCTS

WASHOUT EQUIPMENT

DOSING UNITS



Product Code	No.	Description
036101		SINGLE DETERGENT PUMP
036102		TWIN DETERGENT PUMP

STANDARD FEATURES

- Simple to use
- Simple to install
- Accurately mixes two part cleaners
- Eliminates the need to mix dangerous chemicals

WASHOUT PUMP BOARD



Product Code	No.	Description
036011		SNAPLOK CLEANING PUMP BOARD
036012		PINVALVE CLEANING PUMP BOARD

WASHOUT CANNISTERS

Product Code	No.	Description
019034		5 LTR CLEANING BOTTLE MF-D
019035		5 LTR CLEANING BOTTLE MF-A
019036		15 LTR CLEANING BOTTLE MF-D
019037		15 LTR CLEANING BOTTLE MF-A
019038		19 LTR S/S CLEANING BOTTLE - TWIN NECK
019042		19 LTR SNAPLOK DETERGENT WASHOUT CAN
019043		19 LTR PINVALVE DETERGENT WASHOUT CAN



CLEANING PRODUCTS

CLEANERS

PREMIUM TWIN BEER LINE CLEANER



Product Code	No.	Description
089134		ANDALE PREMIUM TWIN BEER LINE CLEANER (BLC)1 15 LTR
089135		ANDALE PREMIUM TWIN BEER LINE CLEANER (BLC)2 15 LTR
089131		ANDALE PREMIUM TWIN BEER LINE CLEANER 5 LTR - PACK

STANDARD FEATURES

- Simple to use
- Designed for glycol beer systems

PREMIUM ONE BEER LINE CLEANER



Product Code	No.	Description
089138		ANDALE PREMIUM ONE BEER LINE CLEANER 10 LTR

STANDARD FEATURES

- Simple to use
- Designed for glycol beer systems

POWDER CLEANER



Product Code	No.	Description
089070		10KG ANDALE CLEANING POWDER
089071		500G ANDALE CLEANING POWDER

STANDARD FEATURES

- Simple to use
- Designed for cleaning beer dispensing equipment

CLEANING PRODUCTS

CLEANERS

BEEROX POWDER CLEANER



Product Code	No.	Description
089139		5KG BEEROX CLEANING POWDER
089140		12KG BEEROX CLEANING POWDER

ANTI-BACTERIAL SPRAY



Product Code	No.	Description
089080		5LTR ANDALE ANTI-BACTERIAL SPRAY
089081		500ML ANDALE ANTI-BACTERIAL SPRAY

STANDARD FEATURES

- Simple to use
- Designed fto sanitise tapping equipment including keg couplers and transfer leads.

SAFETY KIT



NO RINSE SANITISER



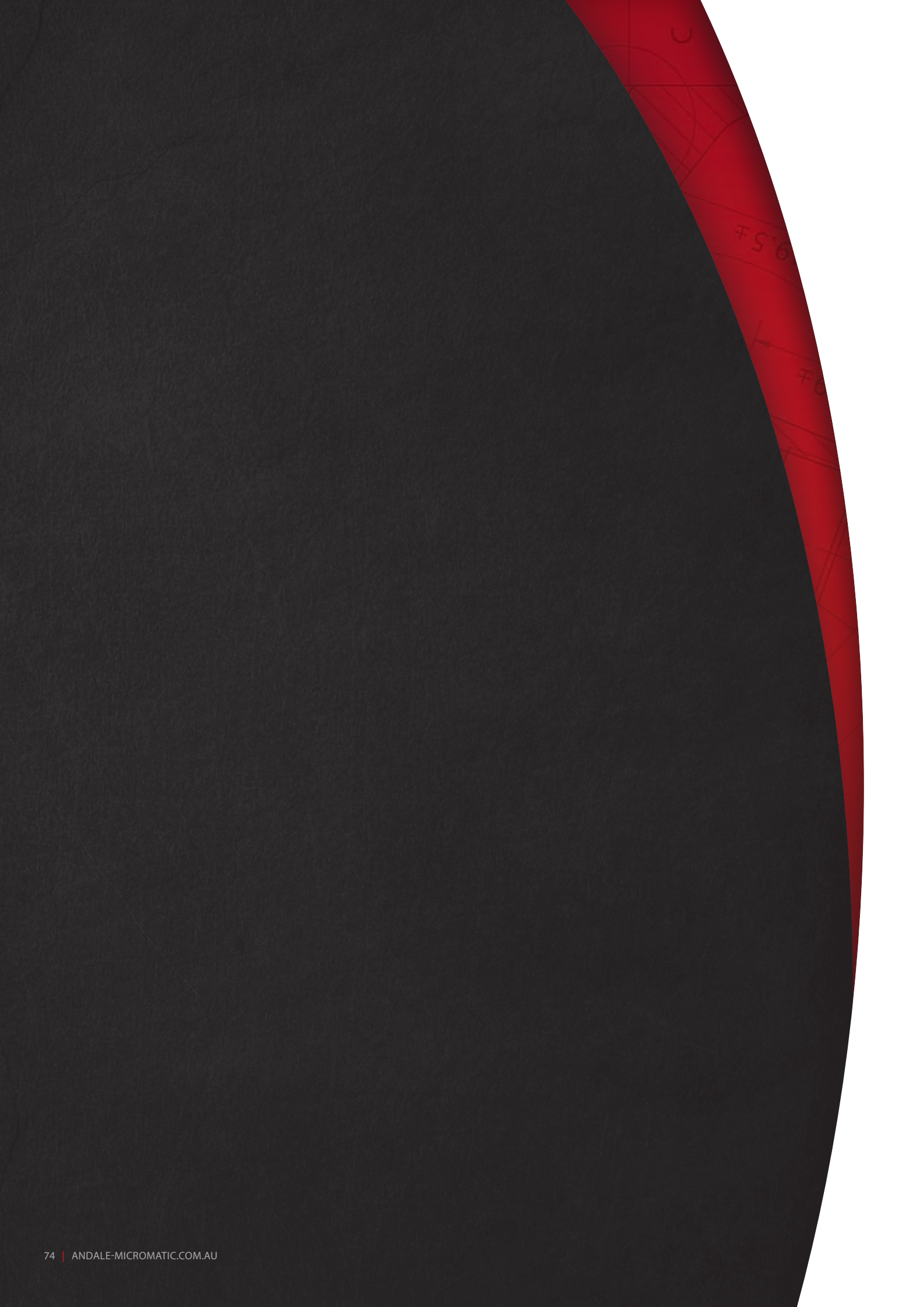

ANDALE MICRO MATIC

KEG COUPLERS

For any draught beer or soft drink system the performance of the keg coupler is vital. The keg coupler connects the gas and beverage lines to the keg and ensures a pressurised flow.

Andale Micro Matic offers a full range of standard Standard Couplers.

All our couplers are providing the highest level of safety, user friendly operations, easy cleaning and ergonomic design:

- The stainless steel housing and POM lower part ensures long-term durability of the Micro Matic handle.
- The handle is ergonomically designed for easy and safe operation.
- The full range of Micro Matic keg couplers offer great opportunities for individually branded labels on the handle
- Optional stainless steel or tin-nickel plated brass.



STANDARD COUPLER A-SYSTEM



PARTS



HIGHLIGHTS

- Long-term durability of the handle due to stainless steel and POM lower part
- Long-term durability
- Convenience in use
- A high performance of the main gasket
- Body design and surface finish of high quality

Product Code	No.	Description	Finish
023021 (023003)	1	MF-AB EG COUPLER-5/8\"BSP	S/S
023022		MF-AB KEG COUPLER - SNAPLOK	
Z023004	2	MF-A KEG SEAL	
Z023005	3	MF-A BODY O'RING	
098361 (Z023009)		MF-A KEG COUPLER SERVICE KIT	
Z023026	4	F1 HANDLE PIN	
Z023027	5	F1 HANDLE	
Z023101	6	TORPEDO NON RETURN VALVE	
Z023102		TORPEDO VALVE RETAINER	
	7	MF-AB KEG COUPLER BODY	
	8	MF-AB PROBE	

STANDARD COUPLER D-SYSTEM



PARTS

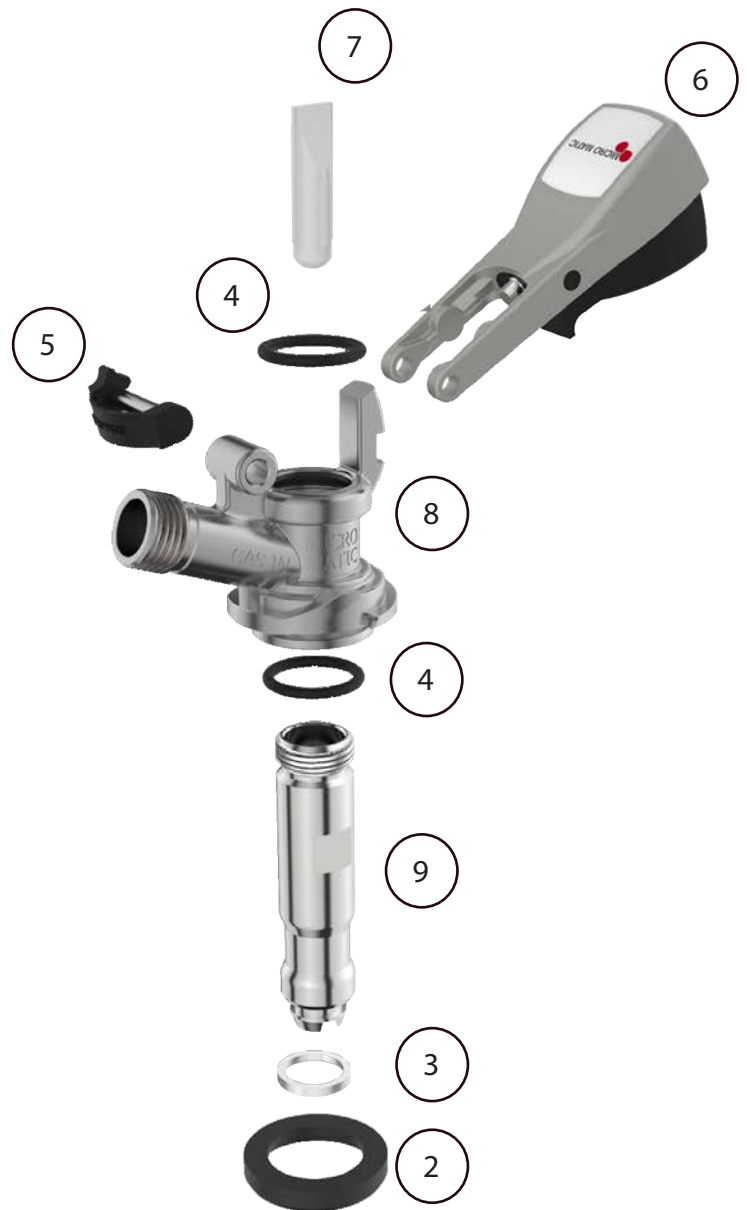

HIGHLIGHTS

- Long-term durability of the handle due to stainless steel and POM lower part
- Long-term durability
- Convenience in use
- A high performance of the main gasket
- Body design and surface finish of high quality

Product Code	No.	Description	Finish
023031	1	MF-D EG COUPLER-5/8" BSP	S/S
023032		MF-D KEG COUPLER - SNAPLOK	
023691 (Z023032)	2	MF-D KEG SEAL	
Z023033	5	MF-D BODY O-RING	
Z023034	3	MF-D PROBE GASKET	
Z023026	4	F1 HANDLE PIN	
Z023027	6	F1 HANDLE	
Z023101	7	TORPEDO NON RETURN VALVE	
Z023102		TORPEDO VALVE RETAINER	
	8	MF-D KEG COUPLER BODY	
	9	MF-D PROBE	

STANDARD COUPLER

KEG COUPLER

Product Code	Description	Finish
023001 (Z023041)	MF-S KEG COUPLER-5/8"BSP	S/S
023021 (023003)	MF-A KEG COUPLER-5/8"BSP	S/S
023031 (Z023031)	MF-D KEG COUPLER-5/8"BSP	S/S
023061 (Z023061)	MF-G KEG COUPLER-1/2"BSP	S/S
023041 (Z023051)	KEY KEG COUPLER-5/8"BSP	S/S



'A' COUPLER
Suits Lion, Coopers, and
Keg Star kegs



'D' COUPLER
Suits CUB and Well style
kegs



'S' COUPLER
Suits European long
probe kegs



'G' COUPLER
Suits European long
probe kegs



KEY KEG COUPLER

STANDARD COUPLER FITTINGS

KEG COUPLER FITTINGS

Product Code	No.	Description	Finish
002006		SNAPLOK ADAPTOR 5/8" BSP	S/S
002010		SNAPLOK ELBOW ADAPTOR R/A	S/S
02502		PINVALVE 5/8" BSPF	S/S
002510		PINVALVE R/A ADAPTOR 5/8"BSP	S/S
014212		6mm C.P. ADAPTOR 5/8"	S/S
014232		6mm C.P. ELBOW ADAPTOR 5/8"	S/S
Z80004		5/8" BSP TO DISCONNECT ADAPTOR - GAS	S/S
Z80003		5/8" BSP TO DISCONNECT ADAPTOR - LIQUID	S/S



5/8" SNAPLOK ADAPTOR

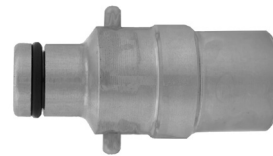

5/8" BSPF PINVALVE
ADAPTOR



SNAPLOK R/A ADAPTOR
5/8"



PINVALVE R/A ADAPTOR
5/8"



6mm R/A ADAPTOR 5/8"



6mm CP ADAPTOR 5/8"



5/8" MF BALL VALVE



5/8" DISCONNECT
ADAPTOR



ANDALE MICRO MATIC

GAS EQUIPMENT

The Andale Micro Matic regulators have been designed to control the flow of CO₂, Nitrogen and mixed gasses for all beverages such as beer and soft drinks.

The regulators from Andale Micro Matic guarantee reliable performance and the stable pressure and flow conditions ensuring excellent pressure setting at any time. Our regulators are produced to high specifications and are tested for durability and long life under all operating conditions. All regulators meet the technical demands in all markets and have, before leaving our plant, gone through a rigorous quality control testing process ensuring accuracy, reliability and optimal performance.

All regulators are available with different working pressures, various inlet (bottle) and outlet threads/connections and with or without shut-off valve.



GAS EQUIPMENT REGULATORS

GEN.4 REGULATOR



GEN.4 INLINE REGULATOR

Product Code	No.	Description
1000060		GEN.4 DUAL GAUGE CO2 REGULATOR
1000061		GEN.4 DUAL GAUGE NITROGEN REGULATOR
1001040		GEN.4 REGULATOR
1005000		GEN.4 INLINE REGULATOR 1000KPA



GEN.4 2 CO2 REGULATOR C/W
440KPA SRV

STANDARD FEATURES

- Complies with AS4267
- 20,000 KPA max inlet
- 400 kpa max pressure
- Suitable for high and low pressure
- 100% Australia Made

HARRIS REGULATORS



8474X REGULATOR
-HIGH FLOW BOTTLE MOUNTED
REGULATOR

Product Code	No.	Description
109000		801 PRESET REGULATOR
109001		821 CO2 REGULATOR - DUAL GAUGE
109004		847/4X TWO STAGE REGULATOR - CO2
109005		847/4X TWO STAGE REGULATOR - NITROGEN



801 REGULATOR

SAFETY RELIEF VALVES

1



2



3



Product Code	No.	Description
101301	1	400KPA RELIEF VALVE
101401	2	400KPA HIGH FLOW RELIEF VALVE
101402		300KPA HIGH FLOW RELIEF VALVE
101410		1200KPA HIGH FLOW RELIEF VALVE
101450	3	400KPA RELIEF VALVE ASSEMBLY
101451		300KPA RELIEF VALVE ASSEMBLY

GAS EQUIPMENT

GAS BOARDS

ANDALE AS5034 CO2 BOARD

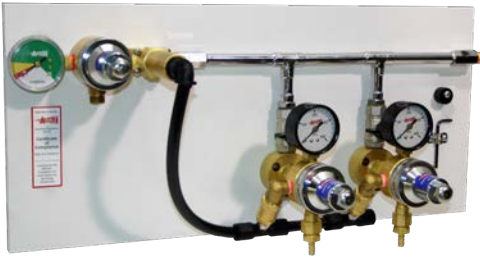

2 WAY ANDALE AS5034 GAS BOARD

Product Code	No.	Description
107201		1 WAY ANDALE CO2 BOARD C/W REGS
107202		2 WAY ANDALE CO2 BOARD C/W REGS
107203		3 WAY ANDALE CO2 BOARD C/W REGS
107204		4 WAY ANDALE CO2 BOARD C/W REGS

STANDARD FEATURES

- 20,000 KPA contents gauge
- Inlinet high pressure regulator
- Available in 1 to 10 regulator configuration
- 100% Australia made

REMOTE REGULATOR BOARD



2 WAY LOW SIDE GAS BOARD

Product Code	No.	Description
107410		2 WAY LOW SIDE GAS BOARD C/W 6mm OUTLETS
107411		3 WAY LOW SIDE GAS BOARD C/W 6mm OUTLETS
107412		4 WAY LOW SIDE GAS BOARD C/W 6mm OUTLETS
107420		2 WAY LOW SIDE GAS BOARD C/W 9.5mm OUTLETS
107421		3 WAY LOW SIDE GAS BOARD C/W 9.5mm OUTLETS
107422		4 WAY LOW SIDE GAS BOARD C/W 9.5mm OUTLETS
107450		LN HIGH SIDE BOARD
028065		11mm x 16mm HIGH PRESSURE TUBING



HIGH SIDE GAS BOARD

STANDARD FEATURES

- Comes standard with 847 flow regulators
- Comes with remote high pressure 801 regulator and 1200KPA relief valve
- Comes complete with high flow 400 KPA relief valves
- Complies with AS5034

ANDALE AS5034 CO2 BOARD



2 WAY HIGH FLOW GAS BOARD

Product Code	No.	Description
107601		1 WAY HR HIGH FLOW CO2 CONTROL BOARD
107602		2 WAY HR HIGH FLOW CO2 CONTROL BOARD
107603		3 WAY HR HIGH FLOW CO2 CONTROL BOARD
107604		4 WAY HR HIGH FLOW CO2 CONTROL BOARD
107605		5 WAY HR HIGH FLOW CO2 CONTROL BOARD

STANDARD FEATURES

- Comes standard with 847 high flow regulators
- Comes with remote high pressure 801 regulator and 1200 KPA relief valve
- Comes complete with high flow 400 KPA relief valves
- Complies with AS5034

GAS EQUIPMENT

GAS PARTS

SAFETY FLEX ARM

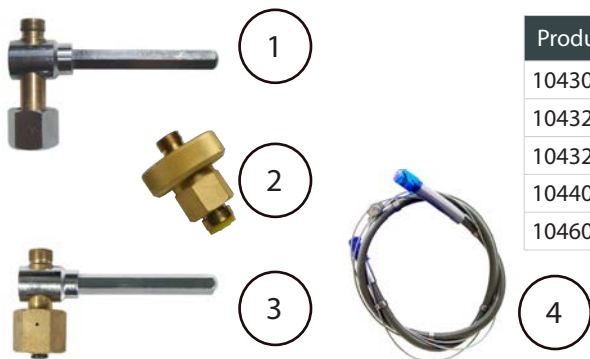

Product Code	No.	Description
104301	1	CO2 HANDLE ASSEMBLY
104321		QUICK FIT CO2 HANDLE FOR FLEX ARM
104322		QUICK FIT C2 HANDLE FOR REGULATOR
104401	3	NITROGEN HANDLE TYPE 50
104607	4	1 METRE SAFETY FLEXIBLE ARM

OVERHEAD BRACKETS AND DROPPERS



Product Code	No.	Description
012501		4mm LINEVALVE
012502		6mm LINEVALVE
026001		4mm SNAPLOK GAS NOZZLE
026002		6mm SNAPLOK GAS NOZZLE
Z026003		NOZZLE GRIP SNAPLOK GAS NOZZLE
026006		6mm BARBED SNAPLOK GAS NOZZLE
038022		6mm TEE - *N/A in NSW
038026		10mm x 6mm x 10mm TEE - *N/A in NSW
038316		PLASTIC OVERHEAD GAS BRACKET BODY
Z100113		1/4" X 6mm BARB FITTING
PI011202S		JG 1/4" BSP x 3/8" STRAIGHT
038422		6mm x 6mm x 6mm BARBED OVERHEAD GAS BRACKET
038425		9.5mm x 6mm x 9.5mm BARBED OVERHEAD GAS BRACKET
0283020		6mm x 10mm x 2m SELF COIL HOSE BLUE
0283021		6mm x 10mm x 2m SELF COIL HOSE GREEN
0283022		6mm x 10mm x 2m SELF COIL HOSE YELLOW
0283023		6mm x 10mm x 2m SELF COIL HOSE BLACK
0283040		6mm x 10mm x 4m SELF COIL HOSE BLUE
0283041		6mm x 10mm x 4m SELF COIL HOSE GREEN
0283042		6mm x 10mm x 4m SELF COIL HOSE YELLOW
0283043		6mm x 10mm x 4m SELF COIL HOSE BLACK

GAS EQUIPMENT

GAS PARTS

SPARE PARTS

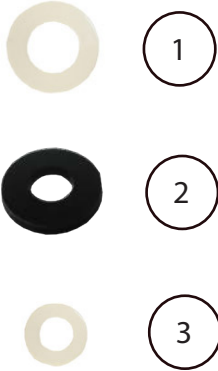

Product Code	No.	Description
104309	1	R.30 NYLON WASHER
104310	2	R.30 POLY WASHER
104311	3	R.31 NYLON WASHER
104001		REG. WALL BRACKET C/W N&O
104101		SINGLE ARM BRACKET
104111		DOUBLE ARM BRACKET
104201		HIGH PRESSURE CHECKVALVE
104221		7/8" NF BLANK CAP
104811		1/4" BLANK PLUG
104821		9/16" PLAIN WASHER
104831		5/8" BSB NUT
104841		FLEXIBLE ARM ADAPTOR FOR DOWNEY
102001		400 KPA x 1/4" PRESSURE GAUGE
102011		1000 KPA x 1/4" PRESSURE GAUGE
102021		20,000 KPA x 1/4" CONTENTS GAUGE
102051		20,000 KPA x 1/8" CONTENTS GAUGE

GAS BOTTLE BRACKET



Product Code	No.	Description
111050		GAS BOTTLE BRACKET - SINGLE
111051		GAS BOTTLE BRACKET - DOUBLE

CELLARWARN CO2 MONITOR



Product Code	No.	Description
111011		CELLARWARN CO2 MONITOR
111012		ALARM REPEATER UNIT - 7M

CO₂ SAFETY

PROTECT *YOUR* WORKERS

CO₂ safety is an important part of the beverage dispensing industry. That's why Micro Matic is committed to the well-being and safety of every professional working in the food service industry. Although education is key, CO₂ safety requires businesses and employees taking action to actually make a change. We believe this is more than just educating individuals, we believe this is about saving lives.

Carbon dioxide leaks are bad news. It may seem that carbon dioxide is harmless—it's in our atmosphere around us and you haven't noticed it, right? But, critical amounts of CO₂ can be extremely hazardous.

Handling CO₂, especially in commercial environments requires attention to your safety as well as other's. Doing so is your key to protecting yourself from liability and avoiding accidents or worse: death. Protect your workers and protect yourself!

LOW LEVELS OF CO₂ ARE HAZARDOUS:

2% CO₂ LEVEL: Drowsy feeling

3% CO₂ LEVEL: Blood pressure rises & hearing can be impaired

5% CO₂ LEVEL: Breathing will become difficult resulting in feeling confused

OVER 5% CO₂ LEVEL: Unconsciousness and possible death may occur







ANDALE MICRO MATIC

GLYCOL EQUIPMENT



REMOTE GLYCOL TANKS

COOLGARDIE GLYCOL TANKS



40 LTR COOLGARIDE
GLYCOL TANK

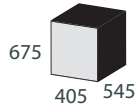

70 LTR COOLGARIDE
GLYCOL TANK

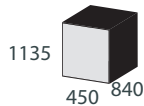

130 LTR COOLGARIDE
GLYCOL TANK

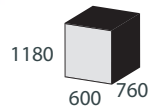

200 LTR COOLGARIDE
GLYCOL TANK

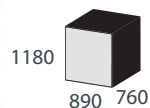

Product Code	No.	Description
09310060		2KW/40V COOLGARDIE G/CHILLER-1P/R404A
09310140		2.5KW/70V COOLGARDIE G/CHILLER-1 SPK2-11/R404A
09310160		3.5KW/70V COOLGARDIE G/CHILLER-1 SPK2-11/R404A
09310161		3.5KW/70V COOLGARDIE G/CHILLER-1 SPK4-11/R404A
09310260		5.4KW/70V COOLGARDIE G/CHILLER-1 SPK2-11/R404A
09310261		5.4KW/70V COOLGARDIE G/CHILLER-1 SPK4-11/R404A
09311060		2.5KW/130V COOLGARDIE G/CHILLER-1 SPK2-11/R404A
09311061		2.5KW/130V COOLGARDIE G/CHILLER-1 SPK2-11/R404A
09311160		3.5KW/130V COOLGARDIE G/CHILLER-1 SPK2-11/R404A
09311161		3.5KW/130V COOLGARDIE G/CHILLER-1 SPK2-11/R404A
09311163		3.5KW/130V COOLGARDIE G/CHILLER-2 SPK2-11/R404A
09311164		3.5KW/130V COOLGARDIE G/CHILLER-2 SPK4-11/R404A
09311260		5.4KW/130V COOLGARDIE G/CHILLER-1 SPK2-11/R404A
09311261		5.4KW/130V COOLGARDIE G/CHILLER-1 SPK4-11/R404A
09311263		5.4KW/130V COOLGARDIE G/CHILLER-2 SPK2-11/R404A
09311264		5.4KW/130V COOLGARDIE G/CHILLER-2 SPK4-11/R404A
09311360		8KW/130V COOLGARDIE G/CHILLER-1 SPK2-11/R404A
09311361		8KW/130V COOLGARDIE G/CHILLER-1 SPK4-11/R404A
09311163		8KW/130V COOLGARDIE G/CHILLER-2 SPK2-11/R404A
09311364		8KW/130V COOLGARDIE G/CHILLER-2 SPK4-11/R404A
09311460		10KW/130V COOLGARDIE G/CHILLER-1 SPK2-11/R404A
09311461		10KW/130V COOLGARDIE G/CHILLER-1 SPK4-11/R404A
09311463		10KW/130V COOLGARDIE G/CHILLER-2 SPK2-11/R404A
09311464		10KW/130V COOLGARDIE G/CHILLER-2 SPK4-11/R404A
09312564		2 X 3.5KW/200V COOLGARDIE G/CHILLER-2P/R404A
09312664		2 X 5.5KW/200V COOLGARDIE G/CHILLER-2P/R404A
09312764		2 X 8KW/200V COOLGARDIE G/CHILLER-2P/R404A
09312774		2 X 10KW/200V COOLGARDIE G/CHILLER-2P/R404A

AVAILABLE IN

- 40 ltr (2kw) - Liquid Line 3/8", Suction line 5/8"
- 70 ltr (2.5kw, 3.5kw and 5.4kw) - Liquid Line 3/8", Suction line 5/8"
- 130 ltr (2.5kw, 3.5kw, 5.4kw) - Liquid Line 3/8", Suction line 3/4"
- 130Ltr (8kw, 10kw and 12kw)- Liquid Line 3/8", Suction line 5/8"
- 200 ltr (3.5kw, 5.4kw, 8kw, 10kw and 12kw - single and dual heat exchanger versions available) (Liquid Line and Suction line varies).
- Pump - Grundfos SPK 2-11 (standard), SPK 4-11 (optional), SPK4-15 (optional)
- Liquid Line - 3/8", Suctions Line 3/4"
- Power required - 10 amp waterproof GPO
- Refrigerant - R404A (standard), 134a and R22 (optional)
- Thermostat - Carel IR33
- Ceiling stand optional
- Hinged lid for easy service

SELF CONTAINED GLYCOL TANKS

COOLGARDIE GLYCOL TANKS

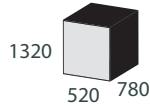

Vertical

40 ltr 2kw Coolgardie Self-contained Glycol Chiller

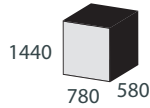

70 ltr 2.7kw Coolgardie Self-contained Glycol Chiller



130 ltr 3.5kw Coolgardie Self-contained Glycol Chiller

Product Code	No.	Description
09310060		2KW/40V COOLGARDIE G/CHILLER-1P/R404A
09310140		2.5KW/70V COOLGARDIE G/CHILLER-1 SPK2-11/R404A
09310160		3.5KW/70V COOLGARDIE G/CHILLER-1 SPK2-11/R404A
09310161		3.5KW/70V COOLGARDIE G/CHILLER-1 SPK4-11/R404A
09310260		5.4KW/70V COOLGARDIE G/CHILLER-1 SPK2-11/R404A

AVAILABLE IN

- 2kw @ -10sst @ 43 degree ambient 40 ltr tank
- 2.7kw @ -10sst @ 43 degree ambient 70 ltr tank
- 3.5kw @ -10sst @ 43 degree ambient 130 ltr tank
- 5kw @ -10sst @ 43 degree ambient 200 ltr tank
- Pump - Grundfos SPK 2-11 (standard), SPK 4-11 (optional), SPK4-15 (optional)
- Liquid Line - 3/8", Suctions Line 3/4"
- Power required - 2kw and 2.7kw 15 amp
- Power required - 3.5kw and 5kw 20 amp
- Hinged lid for easy service
- Custom configurations available

GLYCOL EQUIPMENT

COOLABAH GLYCOL BLOCK



Product Code	No.	Description
092386		COOLABAH 2 GLYCOL BLOCK - 2 COIL 13MM BARB
092387		COOLABAH 4 GLYCOL BLOCK - 2 COIL 13MM BARB
092388		COOLABAH 6 GLYCOL BLOCK - 2 COIL 13MM BARB
092389		COOLABAH 8 GLYCOL BLOCK - 2 COIL 13MM BARB

STANDARD FEATURES

- New design
- Glycol runs through stainless steel circuit
- 100% Australian Made

GLYCOL MANIFOLD



Product Code	No.	Description
092621		2 WAY GLYCOL MANIFOLD - 12.7MM / LOW
092622		2 WAY GLYCOL MANIFOLD - 12.7MM / HIGH
092623		4 WAY GLYCOL MANIFOLD - 12.7MM / LOW
092624		4 WAY GLYCOL MANIFOLD - 12.7MM / HIGH
092625		6 WAY GLYCOL MANIFOLD - 12.7MM / LOW
092626		6 WAY GLYCOL MANIFOLD - 12.7MM / HIGH
092627		8 WAY GLYCOL MANIFOLD - 12.7MM / LOW
092628		8 WAY GLYCOL MANIFOLD - 12.7MM / HIGH
092629		10 WAY GLYCOL MANIFOLD - 12.7MM / LOW
092630		10 WAY GLYCOL MANIFOLD - 12.7MM / HIGH
092631		12 WAY GLYCOL MANIFOLD - 12.7MM / LOW
092632		12 WAY GLYCOL MANIFOLD - 12.7MM / HIGH

GLYCOL EQUIPMENT

GLYCOL EQUIPMENT

GEN.4 REGULATOR



Product Code	No.	Description
0935516		GRUNDFOS SPK2-11 PUMP
0935517		GRUNDFOS SPK4-11 PUMP
0935518		GRUNDFOS SPK4-15 PUMP

GLYCOL



Product Code	No.	Description
092995		ANDALE GLYCOL C/W INHIBITOR 5LTR
092997		ANDALE GLYCOL C/W INHIBITOR 20LTR
089171		DALETRON INHIBITOR - 5 LTR
089181		DALETRON - ICE BANK PRESERVATIVE - 330ML

REFRACTOMETER



Product Code	No.	Description
088501		REFRACTOMETER



ANDALE MICRO MATIC

ICE BANK CHILLERS



ICE BANK CHILLERS

ICE BANK CHILLERS

Product Code	No.	Description
C550140		SINGLE ARTIC CT CHILLER
C550141		DOUBLE ARTIC CT CHILLER
C558010		SILVER 11 ICE BANK CHILLER - 2 COIL
C558020		SILVER 25 ICE BANK CHILLER - 6 COIL
C558030		SILVER 34 ICE BANK CHILLER - 8 COIL



ARTIC CT CHILLER

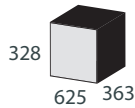

- STANDARD FEATURES**
- Available in single or two tap
 - Removable drip tray
 - Font with loop chilling (easy to fit alternative / customer font)
 - Ice bank - 8kg
 - Water bath - 15 ltr
 - Compressor - 1/5 HP
 - Designed to dispense 43 ltrs / hour @ 20 degree ambient
 - Coils - 5/16" x 15 metres each
 - Made in Italy



SILVER 11 CHILLER

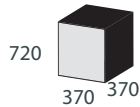

- STANDARD FEATURES**
- 720mm H x 370mm D x 370mm W
 - Ice bank - 11kg
 - Water bath - 21 ltr
 - Designed to dispense 50 ltrs / hour @ 20 degree ambient
 - Pump - 15.8 ltrs / minute 12.1 metre head
 - Compressor - 1/4 HP
 - Coils - 2 x 5/16" x 20 metres each
 - Glycol option available
 - Made in Italy



SILVER 25 CHILLER

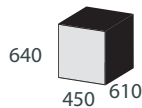

- STANDARD FEATURES**
- 640mm H x 450mm D x 610mm W
 - Ice bank - 25kg
 - Water bath - 43 ltr
 - Designed to dispense 134 ltrs / hour @ 20 degree ambient
 - Pump - 15.8 ltrs / minute 12.1 metre head
 - Compressor - 1/2 HP
 - Coils - 6 x 5/16" x 20 metres each
 - Glycol option available
 - Made in Italy



SILVER 34 CHILLER

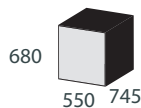

- STANDARD FEATURES**
- 680mm H x 550mm D x 745mm W
 - Ice bank - 34kg
 - Water bath - 75 ltr
 - Designed to dispense 200 ltrs / hour @ 20 degree ambient
 - Pump - 15.8 ltrs / minute 12.1 metre head
 - Compressor - 3/4 HP
 - Coils - 8 x 5/16" x 20 metres each
 - Glycol option available
 - Made in Italy

ICE BANK CHILLERS

WATER DISPENSING EQUIPMENT



ARTIC WATER CHILLER /
CARBONATOR

STANDARD FEATURES

- 460mm H x 490mm D x 300mm W
- Ice bank -8kg
- Water bath - 14ltr
- Compressor - 1/4 HP Danfoss R134A
- Designed to dispense 70 ltrs / hour - 20 degree inlet temp
- Carbonator Pump - 150 ltrs / hour
- Carbonator Capacity - 1 ltr



SILVER 25 MIX

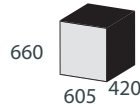

STANDARD FEATURES

- 660mm H x 420mm D x 605mm W
- Ice bank - 25kg
- Water bath - 43 ltr
- Designed to dispense 134 ltrs / hour @ 20 degree ambient
- Pump - 15.8 ltrs / minute 12.1 metre head
- Compressor - 1/2 HP
- 2 beers, still water and carbonated water
- Carbonator Pump - 150 ltrs / hour
- Carbonator Capacity - 1 ltr



REMOTE CARBONATOR

STANDARD FEATURES

- 485mm H x 380mm D x 200mm W
- Carbonator Pump - 300 ltrs / hour
- Carbonator Capacity - 2 ltr
- Add sparkling water to your ice bank chiller

System Requirements

- 1/2" water supply
- 10 amp power



ANDALE MICRO MATIC

MOBILE BARS AND PORTABLE EQUIPMENT



MOBILE BARS

THE BEER BAR

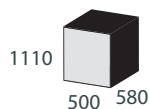

Product Code	No.	Description
C550050		BEER BAR - 1 TAP
C550060		BEER BAR - 2 TAP
C550070		BEER BAR - 3 TAP
C550080		BEER BAR - 4 TAP

STANDARD FEATURES

- 1110mm H (plus chosen font height) x 500mm W x 580 mm D
- Available in 1, 2, 3 or 4 tap configuration
- Ice bank - 34kg
- Water bath - 75 ltr
- Compressor - 3/4 HP
- Designed to dispense 200 ltrs / hour @ 20 degree ambient
- Chiller made in Italy
- Dispenser made in Australia

THE MULTIPOUR BAR

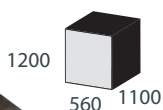

Product Code	No.	Description
C558090		MULTIPOUR BAR - 4 PRODUCT

STANDARD FEATURES

- 1200mm H x 560mm W x 1100 mm D
- Available in 2 or 4 tap configuration (Easy to switch between 2 and 4 product dispense)
- Ice bank - 34kg
- Water bath - 75 ltr
- Compressor - 3/4 HP
- Designed to dispense 200 ltrs / hour @ 20 degree ambient
- Available with adjustable feet or lockable castors
- Chiller made in Italy
- Dispenser made in Australia

MINI DECORATIVE BAR



STANDARD FEATURES

- Taipan font (1 to 4 taps available)
- Timber serving top
- Decorative stainless steel finish
- High capacity Ice Bank Beer cooler
- Designed to dispense 50ltrs / hour @ 20 degree ambient
- Beer taps
- Leads with Snaplok nozzles
- Stainless Steel drip tray
- Lockable castors
- Australian made

MOBILE BARS

STAINLESS STEEL MOBILE BAR



STANDARD FEATURES

- 11.5" Andale T font (1 to 6 taps available)
- Stainless steel finish (Re-enforced)
- Designed to dispense 100 ltrs per / hour @ 20 degrees ambient
- Leads with Snaplok nozzles
- Stainless steel drip tray
- Beer taps and adaptors
- Lockable castors
- 2000mm L x 700mm D (including serving ledge over hang) x 1060mm H 1200mm (serving ledge)
- Australian made

DECORATIVE MOBILE VAR



STANDARD FEATURES

- 11.5" Andale T font (1 to 6 taps available)
- Timber serving top
- Decorative stainless steel finish
- Designed to dispense 100 ltrs per / hour @ 20 degrees ambient
- Leads with Snaplok nozzles
- Stainless steel drip tray
- Beer taps and adaptors
- Lockable castors
- 2000mm L x 700mm D (including serving ledge over hang) x 1060mm H (bench height) 1200mm (servinf ledge)
- Optional Ice Well, Cash Drawer and Glass Racks available
- Australian made

KEG BAR



STANDARD FEATURES

- 11.5" Andale T font (1 to 6 taps available)
- Stainless steel shell
- Designed to dispense 100 ltrs per / hour @ 20 degrees ambient
- Leads with Snaplok nozzles
- Beer taps and adaptors
- Lockable castors
- 1620mm L x 720mm D x 1000mm H
- Optional Ice Well, Cash Drawer and Glass Racks available
- Australian made

MOBILE ACCESSORIES



TIMBER TOP

Available as an upgrade for the Stainless Steel Mobile Bar



ICE WELL

Available as an upgrade for the Stainless Steel Mobile Bar and Decorative Mobile Bar.



CASH DRAWER

Available as an upgrade for the Stainless Steel Mobile Bar



CUP DISPENSER

Available as an upgrade for the Stainless Steel Mobile Bar, Decorative Mobile Bar and Keg Bar.



GLASS RACKS

Available as an upgrade for the Stainless Steel Mobile Bar in either three or four tier.



SPEED RACK

Available as an upgrade for the Stainless Steel Mobile Bar, Decorative Mobile Bar and Keg Bar.

CUSTOM MOBILE BARS

CUSTOM MOBILE BARS

Andale Micro Matic can design and fabricate custom mobile bars to suit your needs. From fully branded mobile bars, customer sizes and custom tap configurations, Andale Micro Matic can design a mobile bar to your specifications. Please contact your local Andale Micro Matic office for more information.

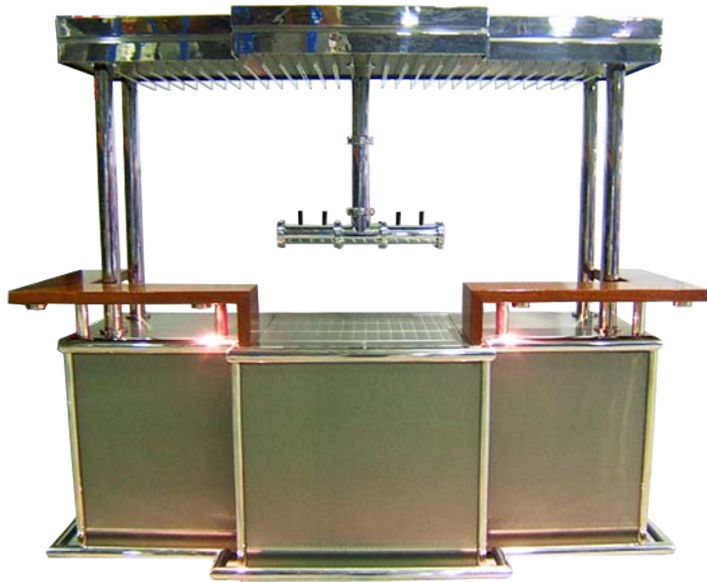

MOBILE BARS AND PORTABLE EQUIPMENT

COLD PLATE COOLERS

An Andale Micro Matic Cold Plate Cooler is a simple and convenient way to dispense ice cold beer anywhere, any time. All you need to do is fill the cooler with ice and the "Cold Plate" inside the cooler acts as a heat exchanger which chills your beer. Simple, convenient and portable. Our cold plate coolers are used by all of Australia's major breweries, catering companies and keg hire experts.

COLD PLATE



STANDARD FEATURES

- Available in single or double coil
- 5 metre x 1/4" OD beer coil
- 100% Australian made

COLD PLATE COOLER



STANDARD FEATURES

- Snaplok outlet
- 2 metre beer lead
- Cold plate
- No electricity required. All you need is ice to chill your beer
- Durable Eskey brand cooler
- Available in a pack complete with tap or beer gun, gas regulator and keg coupler
- 100% Australian made

DELUXE COLD PLATE COOLER



STANDARD FEATURES

- Snaplok outlet
- 2 metre beer lead
- Cold plate
- No electricity required. All you need is ice to chill your beer
- Available in a pack complete with tap or beer gun, gas regulator and keg coupler
- Also available as a high volume version with an 11kg cold plate and 6m x 5/16" coils
- 100% Australian made

DELUXE COOLER WITH FONT



STANDARD FEATURES

- Chrome beer font
- Snaplok outlet
- 2 metre beer lead
- Cold plate
- No electricity required. All you need is ice to chill your beer
- Portable and durable cooler
- 100% Australian made





ANDALE MICRO MATIC

FLEXIDRAFT™

Increasing the quality of the beer you serve will help you maximize the potential of your business. Experience speaks for itself. Good draft beer sells better.

We all know what a bad beer tastes like. And we'll never hurry back to the same place to get another one. Great beer, on the other hand, turns your customers into walking adverts for your business. Increasing your revenues and winning you new customers, every day.

The One-Way Beer Line completely changes the draft business. It keeps the beer fresh and eliminates the hidden costs of conventional systems related to cleaning and maintenance.

It is easy to change and ensures a perfect beer every time. And most importantly, it makes draft beer more profitable for breweries and outlets.



FLEXIDRAFT™ STAR

Free-standing and mobile systems.

FlexiDraft™ STAR is an integrated solution that combines all the benefits of a full branded FlexiDraft™ font with flexible cooling options in different sizes, allowing up to four taps on each unit.

FlexiDraft™ STAR comes with professional, durable fridges for more accurate and eco-friendly cooling.

The STAR range is easy to install (Plug & Play) and our selection of different fridge sizes is suitable for a wide range of common keg combinations.



FLEXIDRAFT™ STAR 15

Fonts	Dimensions (W x D x H)	Specifications
1-2	650 x 680 x 1083 mm	Top mounted cooling cassette

Keg combinations (examples):



FLEXIDRAFT™ STAR 25

Fonts	Dimensions (W x D x H)	Specifications
1-2	736 x 778 x 1102 mm	Top mounted cooling cassette

Keg combinations (examples):



FLEXIDRAFT™ STAR 30

Fonts	Dimensions (W x D x H)	Specifications
1-3	1230 x 640 x 987 mm	Side mounted cooling cassette

Keg combinations (examples):



FLEXIDRAFT™ STAR 40

Fonts	Dimensions (W x D x H)	Specifications
1-4	1520 x 700 x 1070 mm	Center mounted cooling cassette

Keg combinations (examples):



FLEXIDRAFT™ ACCESSORIES

To complete your FlexiDraft™ solution, Micro Matic offers a wide range of accessories and upgrades, that allows you to brand the unit or fit it for a specific installation.

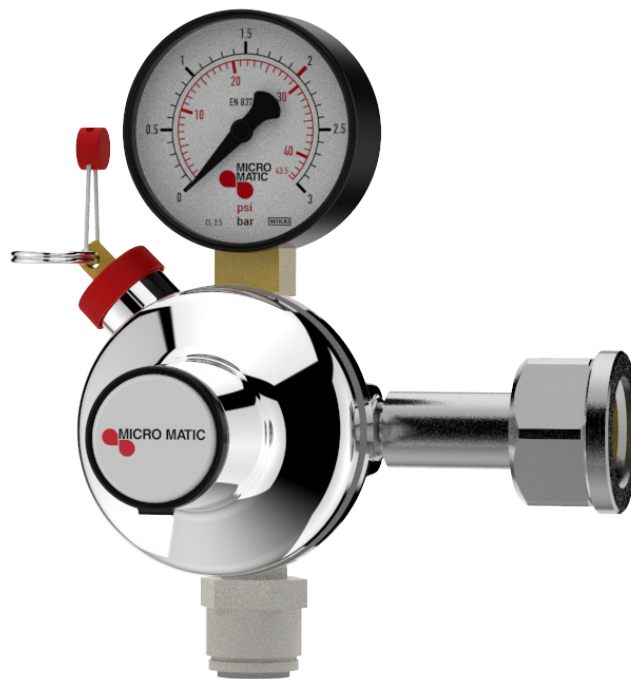

FLEXIDRAFT™
KEG COUPLERS



System	No.	Specification
A	①	3/8" push-in connection
G	②	3/8" push-in connection
M	②	3/8" push-in connection
S	④	3/8" push-in connection
D	⑤	3/8" push-in connection
KeyKeg	⑥	3/8" push-in connection

COPENHAGEN TOWER - SINGLE FONT

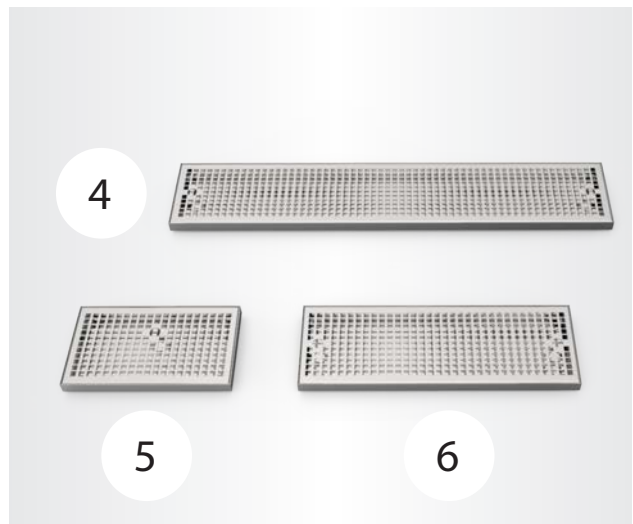
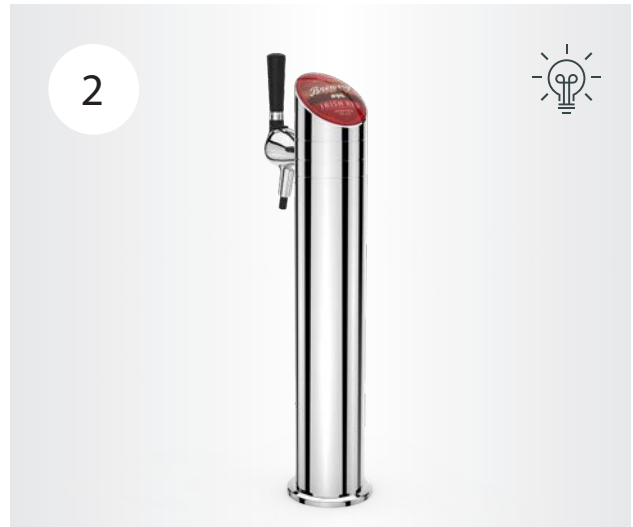
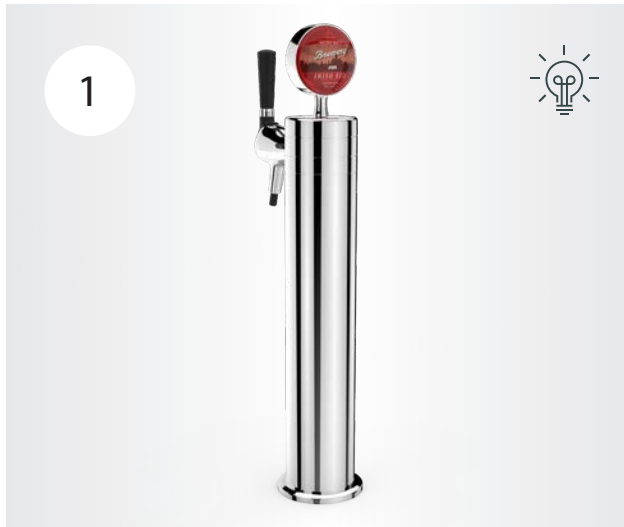

No.	Specification
①	Copenhagen Tower with illuminated round frog eye lens
-	Copenhagen Tower with illuminated round frog eye lens (short version, 460 mm)
②	Copenhagen Tower with illuminated oval fish eye lens
③	Copenhagen Tower without illumination
-	Copenhagen Tower without illumination (short version, 460 mm)
④	Drip tray, Small, stainless steel W 300 x D 170 x H 25 mm
⑤	Drip tray, Medium, stainless steel W 500 x D 170 x H 25 mm
⑤	Drip tray, Large, stainless steel W 900 x D 170 x H 25 mm

FLEXIDRAFT™

COPENHAGEN TOWER - DUO FONT

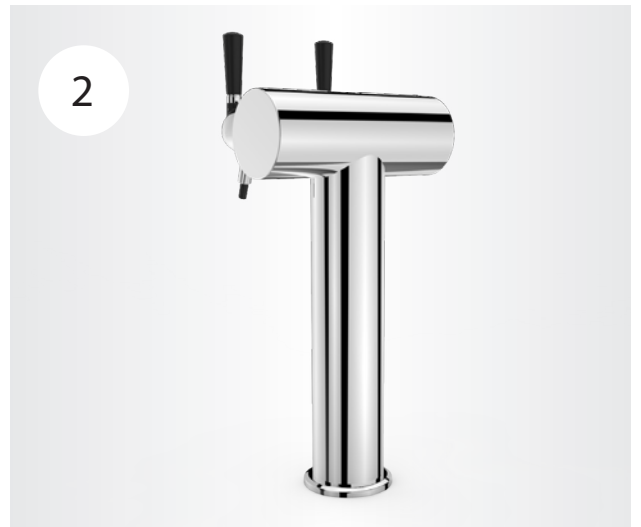
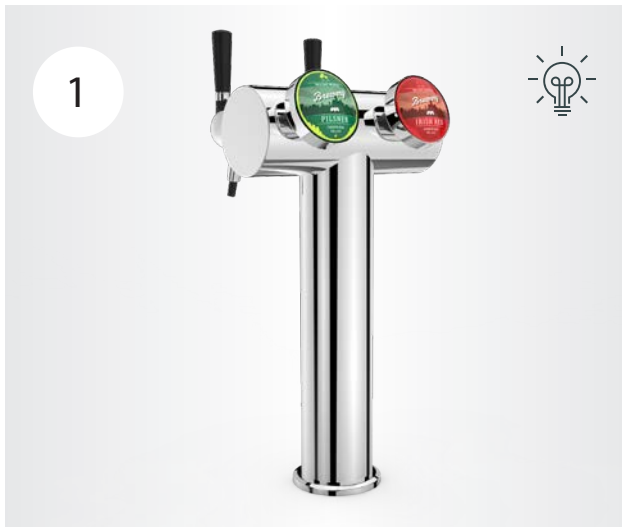

FLEXIDRAFT™

WALL TAP



No.	Specification
①	Copenhagen Duo Tower chrome with illuminated round frog eye lenses
②	Copenhagen Duo Tower chrome without illumination
③	Wall tap set

GAS EQUIPMENT

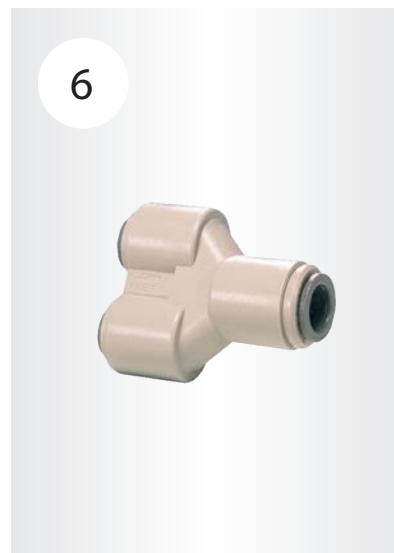
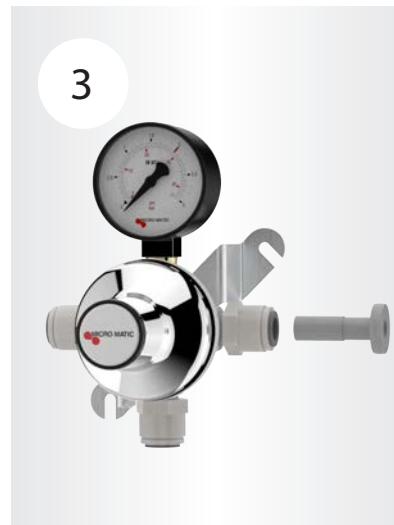
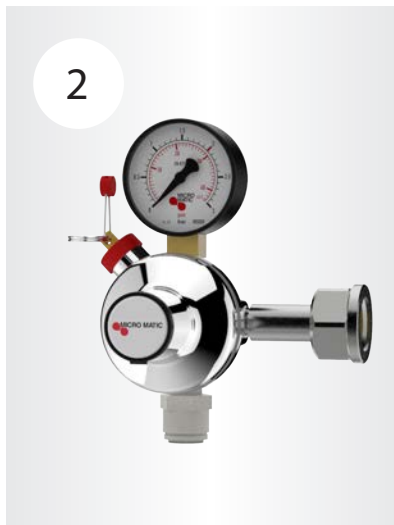
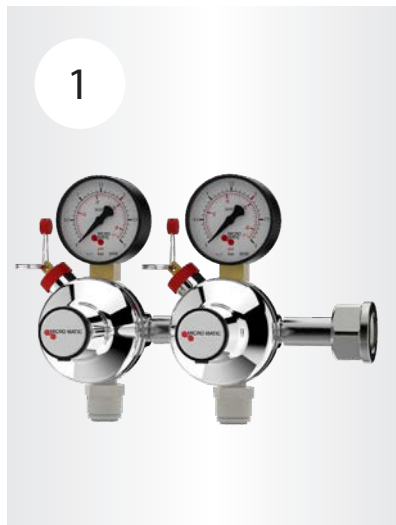



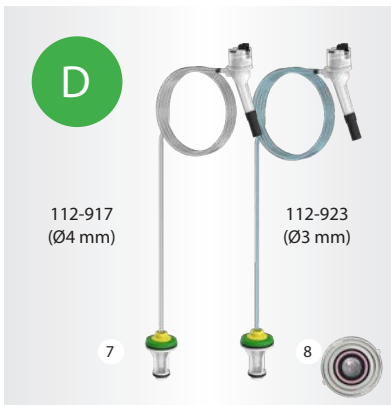
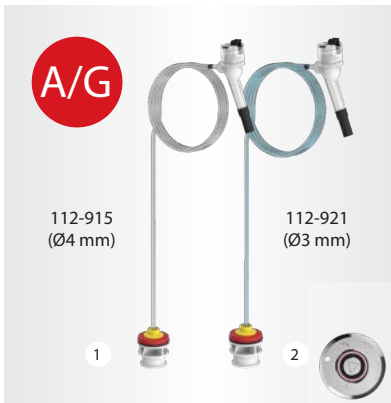

No.	Description	Specification
①	PremiumPLUS double battery, 0-3/2 bar/PSI	Inlet - W 21.8 x 1/14, Outlet 2 x 3/8" JG
②	PremiumPLUS 1 line, 0-3/2 bar/PSI	Inlet - W 21.8 x 1/14, Outlet - 3/8" JG
③	PremiumPLUS 1 line, Secondary 0-3/2 bar/PSI (incl. wall bracket)	Inlet - 3/8" JG (incl. plug), Outlet - 3/8" JG
-	Red/Green indicator for empty/full CO ₂ Bottle	
④	2 meter Valpar Brewmaster 2	OD 3/8" x ID 1/4"
⑤	5 meter Valpar Brewmaster 2	OD 3/8" x ID 1/4"
⑥	CO ₂ distributor	JG 3/8" SPLITTER

ONE-WAY BEER LINES, STANDARD (1,4 m)



BEER LINE GUIDE, 1,4 m:

Inner Ø:	Tubing color:	Beer Type:
Ø4 mm	Transparent tube	For normal carbonated beers with working pressure below 1,1 bar
Ø3 mm	Blue Tube	For beers with high carbonation and working pressure above 1,1 bar

System (Color)	Item #	No.	Specification
A/G 	112-915	①	Color code Red, Ø4 mm (transparent tube), 1,4 meter
	112-921	②	Color code Red, Ø3 mm (blue tube), 1,4 meter
M 	112-920	③	Color code Purple, Ø4 mm (transparent tube), 1,4 meter
	122-111	④	Color code Purple, Ø3 mm (tube blue), 1,4 meter
S 	112-916	⑤	Color code Blue, Ø4 mm (transparent tube), 1,4 meter
	112-922	⑥	Color code Blue, Ø3 mm (blue tube), 1,4 meter
D 	112-917	⑦	Color code Green, Ø4 mm (transparent tube), 1,4 meter
	112-923	⑧	Color code Green, Ø3 mm (blue tube), 1,4 meter
KeyKeg 	122-475	⑨	Color code White, Ø3,2 mm (orange tube), for working pressure of 1,5 bar, 1,4 meter

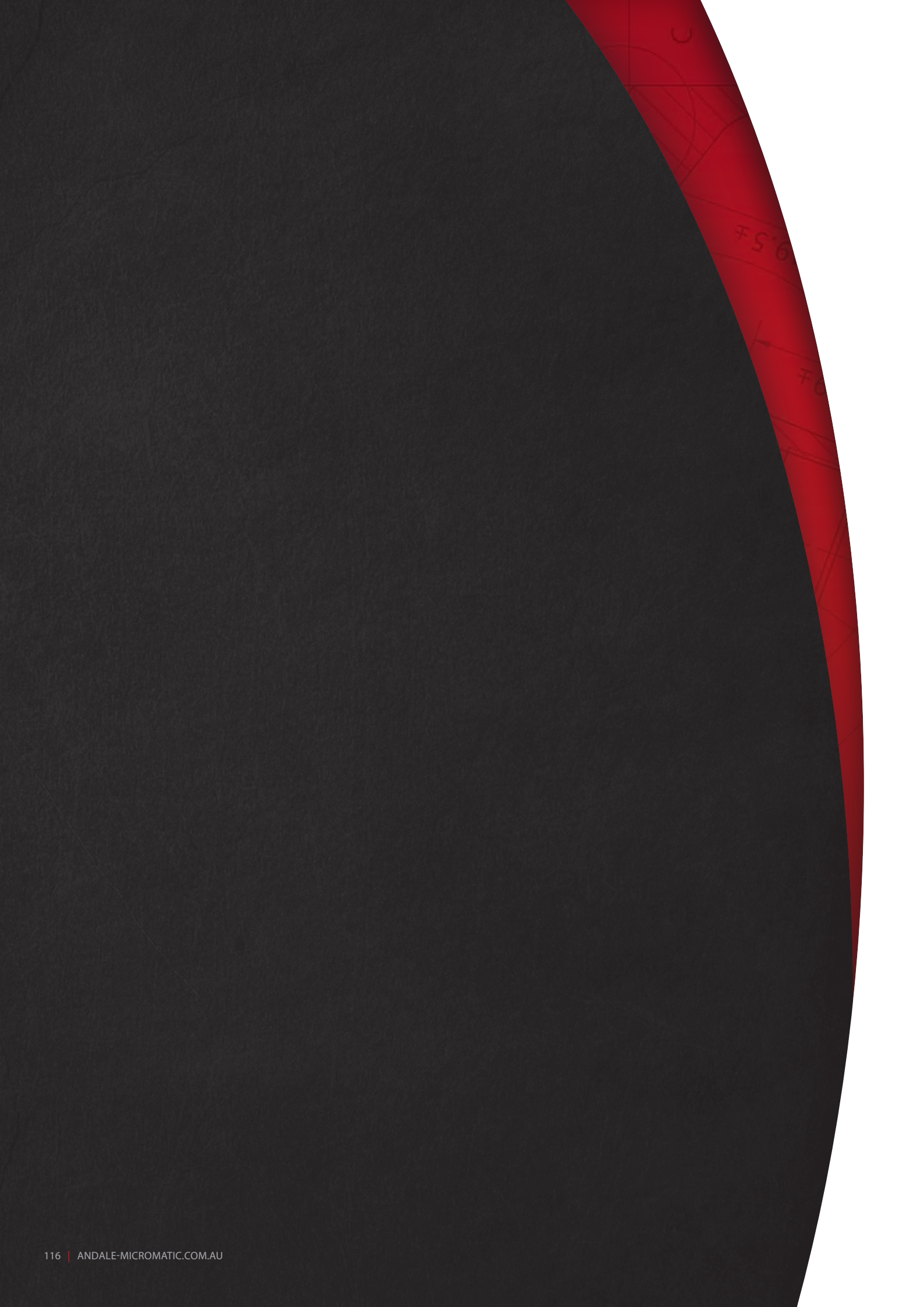

ANDALE MICRO MATIC

TUBING & PYTHON

Valpar Micro Matic is recognised as one of the world's leading manufacturers of Tubing & Python for the dispense industry. State of the art extrusion machines - capable of high precision output - are utilized to manufacture Valpar Micro Matic high quality Tubing & Python.

Valpar Micro Matic are specialists in the art of monolayer and multilayer extrusion, bringing you a vast range of solutions to meet and exceed the needs of dispensing today and into the future.

Whether it is for a small bar at an open air concert or for a major entertainment arena, Valpar Micro Matic provide customised, quality, high performance solutions tailored to you:

- Protecting taste
- Colder temperatures
- Improved hygiene
- More energy efficient
- And most importantly, within your specification

All Valpar Micro Matic beverage tubing complies with EU Regulation 10/2011 for "Plastic Materials and Articles intended to come into contact with food".

Our tubing materials also comply with the Code of Federal Regulations issued by the Food and Drug Administration (FDA), Title 21; in particular paragraphs CFR 177.1520 - Olefin Polymers, CFR 177.1500 (b) (5.1) - Nylon Polymers; CFR 177.1350 - EVA Copolymers.



ANDALE MICRO MATIC

BEVERAGE TUBING SOLUTIONS



ANDALE MICRO MATIC

SUPERFLEXMASTER

DESCRIPTION

This is a two layer tube offering good flexibility and hygiene. Suitable for most cold drinks dispense systems.

FEATURES & BENEFITS:

- Good flexibility - better than MDP and EVA
- Ultra-smooth inner layer
- Taint free
- Improved hygiene – Reduced line cleaning over MDP

SPECIFICATION HIGHLIGHTS:

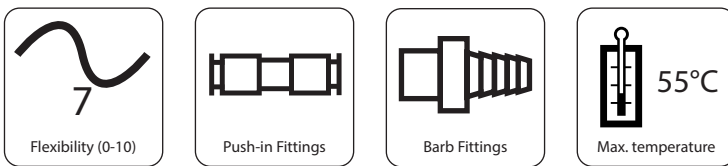

APPLICATIONS:



TECHNICAL SPECIFICATIONS:

Ø, Inner/outer in mm
4.0 x 8.0
5.0 x 8.0
6.0 x 9.5
8.0 x 12
10.0 x 15.0
12.7 x 17.4

TUBING LAYERS:



ANDALE MICRO MATIC

BREWMASTER 2 (BAM)

DESCRIPTION

A multilayer nylon lined tube developed to increase hygiene and product quality within the beer industry.

FEATURES & BENEFITS:

- Highly engineered for consistent quality
- Taint free and ultra-smooth inner layer
- Low gas permeation and reduced bacterial growth
- Maintains carbonation levels of dispensed product
- Available with UV protection for outdoor applications, primarily as a dispense gas line

SPECIFICATION HIGHLIGHTS:

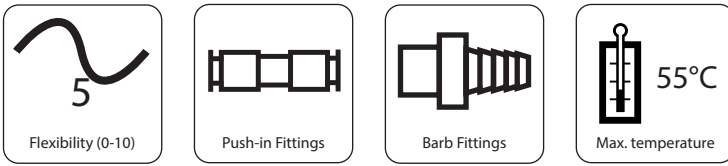

APPLICATIONS:



TECHNICAL SPECIFICATIONS:

Ø, Inner/outer in mm
4.0 x 8.0
5.0 X 8.0
6.3 x 9.5
8.0 x 12.0
9.5 x 12.7

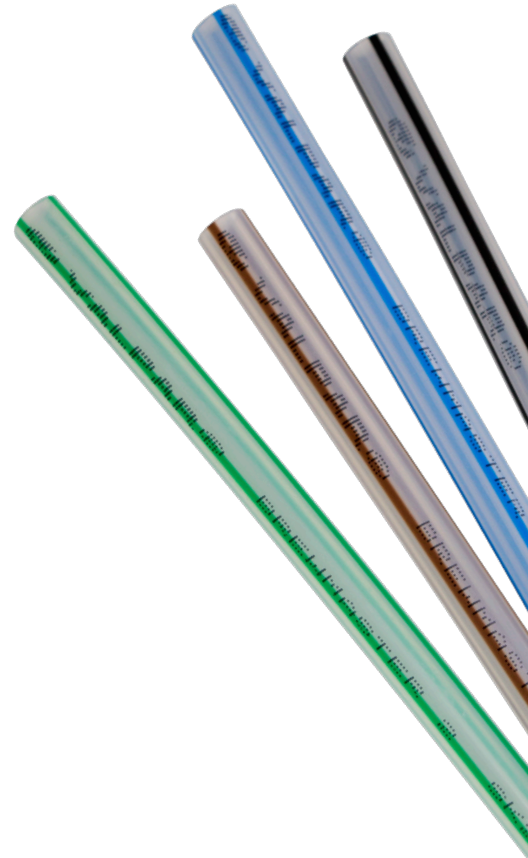

TUBING LAYERS:

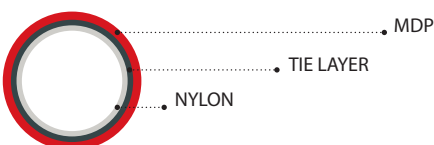



ANDALE MICRO MATIC

BEVERAGE PYTHON SOLUTIONS



ANDALE MICRO MATIC

TAPED PYTHON

DESCRIPTION

Andale Micro Matic manufacture a range of taped pythons to best suit individual customer requirements.

Available in different line configurations, tube types/sizes and insulation thicknesses.

FEATURES & BENEFITS:

- Designed to give maximum thermal transfer between cooling and product lines, ensuring lowest possible dispense temperature.
- Lines manufactured to close dimensional tolerances to suit both internal (barb and clip) and 'push in' fittings.
- Consistent product performance.
- Fully customisable for individual requirements (1-24 product lines).
- Tubing within the python can be cabled to allow greater flexibility of the overall python, reducing the minimum bend radius.

CERTIFICATIONS/APPROVALS:

- All tubing materials comply with EU Regulation 10/2011 - plastic materials and articles intended to come into contact with food.
- In compliance with the relevant paragraphs of FDA Code of Regulation, Title 21.
- Python is fire rated to BS476, Part 7, Class 1 (Surface spread of flame).

APPLICATIONS:



PYTHON LAYERS:

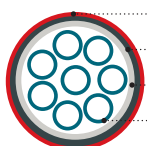

- PROTECTIVE TAPE
- INSULATION
- CLINGWRAP BARRIER FILM
- COOLING/PRODUCT LINES



MOBILE BARS AND PORTABLE EQUIPMENT

TUBING & PYTHON

PYTHON



Python Cable Tie and Bracket

STANDARD FEATURES

- Beer python available with either 6.3mm, 8mm or 9.5mm Brewmaster 2 tubing
- Available with 19mm, 25mm or 32mm insulation
- Custom configurations upon request
- Glycol python available
- Post mix python available
- Eco X Energy python available
- Q-guard python available

FLEXMASTER TUBING



Product Code	No.	Description
028501		4mm x 8mm SUPERFLEXMASTER TUBING
028502		5mm x 8mm SUPERFLEXMASTER TUBING
028503		6mm x 9.5mm SUPERFLEXMASTER TUBING
028503B		6mm x 9.5mm SUPERFLEXMASTER TUBING-Blue
028504		8mm x 12mm SUPERFLEXMASTER TUBING
028505		10mm x 15mm SUPERFLEXMASTER TUBING
028506		12.7mm x 17.4mm SUPERFLEXMASTER TUBING

BREWMASTER TUBING



Product Code	No.	Description
028702		5mm x 8mm BREWMASTER 2 TUBING
028703		6.3mm x 9.5mm BREWMASTER 2 TUBING
028704		7mm x 10mm BREWMASTER 2 TUBING
028705		8mm x 12mm BREWMASTER 2 TUBING
029706		9.5mm x 12.7mm BREWMASTER 2 TUBING
028711		4mm x 8mm BREWMASTER 2 TUBING

TUBING



Product Code	No.	Description
Z028014		PVC TUBE 9.5mm X 14.2mm CLEAR BAG IN BOX TUBE
Z028016		PVC TUBE 1/2" (ICE BANK OVER-FLOW)
Z028031		12.7mm BRAIDED PVC TUBE
028035		25mm BRAIDED PVC TUBE
Z028095		BLACK UV TUBING 6.7mm x 11mm
Z028096		BLACK UV TUBING 9.5mm x 13.8mm
Z028097		BLACK UV TUBING 12.7mm x 17.4mm
Z028196		9.5mm x 12.7mm RIGID WHITE PVC

ARMAFLEX INSULATION



Other Armaflex sizes are available upon request

Product Code	No.	Description
028211		9mm x 6mm ARMAFLEX
028212		9mm x 10mm ARMAFLEX
028213		9mm x 12mm ARMAFLEX
028227		13mm x 6mm ARMAFLEX
028228		13mm x 10mm ARMAFLEX
028229		13mm x 12mm ARMAFLEX
028230		13mm x 15mm ARMAFLEX
028264		159mm x 6mm ARMAFLEX
028269		19mm x 32mm ARMAFLEX
028272		19mm x 42mm ARMAFLEX





ANDALE MICRO MATIC

ACCESSORIES & FITTINGS



FITTINGS

JOHN GUEST FITTINGS



Product Code	No.	Description
JG NC462		15mm x 1/2" STRAIGHT CONNECTOR
JG PI011202S		JG 1/4" BSP x 3/8" SF
JG PI011224S		JG 1/2" NPTF x 3/8" SF STRAIGHT
JG PI011604S		JG 1/2" BSP x 1/2" STRAIGHT ADAPTOR
JG PI0212S		JG 3/8" EQUAL TEE
JG PI0316S		JG EQUAL ELBOW CONNECTOR 1/2"
JG PI0412S		JG 3/8" SF EQUAL STRAIGHT
JG PI0416S		JG 1/2" SF EQUAL STRAIGHT
JG PI0816S		JG 1/2" PLUG
JG PI091604S		JG 1/2" BSP x 1/2" SF SWIVEL
JG PO201210S		JG 3/8" SF x 5/16" STRAIGHT ADAPTOR
JG P12312S		JG 3/8" 2 WAY DIVIDER
JG PI251008S		JG 5/16" x 1/4" BARB HOSE STEM
JG PI251012S		JG 5/16" x 3/8" BARB HOSE STEM
JG PI251208S		JG 3/8" x 1/4" BARB HOSE STEM
JG PI251210S		JG 3/8" x 5/16" BARB HOSE STEM
JG PI251612S		JG 1/2" x 3/8" BARB HOSE STEM
JG PI251616S		JG 1/2" x 1/2" BARB HOSE STEM
JG PI291008S		JG 5/16" x 1/4" BARB HOSE ELBOW
JG PI451014FS		JG 1/2" BSP x 5/16" SF FEMALE
JG PI451015FS		JG 5/8" BSP x 5/16" SF
JG PI451215FS		JG 5/8" x 3/8" SF FEMALE
JG PI451615FS		JG 5/8" BSP x 1/2" SF
JG PISV0412S		SHUT OFF VALVE 3/8" SPEEDFIT
JG PIUB16S		JG 1/2" U BEND
JG PM010802S		JG 1/4" BSP x 5/16" STRAIGHT
JG PM0208E		JG 8mm EQUAL TEE
JG PM0208S		JG 5/16" EQUAL TEE
JG PM0408S		JG 5/16" EQUAL JOINER
JG PM2308S		JG 5/16" 2 WAY DIVIDER
JG PM250808S		JG 5/16" x 5/16" BARB
JG PM4508F4S		JG 5/16" x 7/16" FEMALE ADAPTOR
JG RM0310E		EQUAL ELBOW 10MM
JG SI041012S		JG 5/16" SS x 3/8" SF STRAIGHT
JG SI421012S		JG 5/16" SS x 3/8" SF FLOWBEND
JG SI421210S		JG 3/8" SS x 5/16" SF FLOW BEND
JG SI421212S		JG 3/8" SS x 3/8" SF FLOWBEND
JG SM030808S		JG 5/16" SS x 5/16" SF ELBOW
JG SM040808S		JG 5/16" SS x 5/16" SF STRAIGHT
JG SM420808S		JG 5/16" x 5/16" SF FLOW BEND
JG SPAN 1		JG SUPERSEAL SPANNER
JG SVMC-10		JG MOUNTING CLIP

FITTINGS

SPLICERS



Product Code	No.	Description
0106011		4mm x 4mm SPLICER
0106013		4mm x 6mm SPLICER
0106015		4mm x 9.5mm SPLICER
0106021		5mm x 5mm SPLICER
0106022		5mm x 6mm SPLICER
0106024		5mm x 8mm SPLICER
0106025		5mm x 9.5mm SPLICER
0106031		6mm x 6mm SPLICER
0106034		6mm x 9.5mm SPLICER
0106051		8mm x 8mm SPLICER
0106061		9.5mm x 9.5mm SPLICER
0106062		9.5mm x 12.7mm SPLICER
0106071		12.7mm x 12.74mm SPLICER
0106169		6mm BLANK PLUG
0106170		9.5mm BLANK PLUG
0106171		12.7MM BLANK PLUG
0107021		1/2" U BEND
0107022		1/2" U BEND WITH TAKE OFF
0107023		1/2" ELBOW
038022		6mm x 6mm x 6mm TEE
038026		10mm x 6mm x 10mm TEE

OETIKER CLAMPS



Product Code	No.	Description
992001		007, 0-505 R OETIKER O/E STEPLESS CLAMP
992002		008, 0-505 R OETIKER O/E STEPLESS CLAMP
992003		008, 7-505 R OETIKER O/E STEPLESS CLAMP
992004		009, 5-505 R OETIKER O/E STEPLESS CLAMP
992007		010, 5-505 R OETIKER O/E STEPLESS CLAMP
992009		011, 3-505 R OETIKER O/E STEPLESS CLAMP
992010		011,8-505 R OETIKER O/E STEPLESS CLAMP
992013		013, 3-505 R OETIKER O/E STEPLESS CLAMP
992014		013, 8-505 R OETIKER O/E STEPLESS CLAMP
992015		014, 5-505 R OETIKER O/E STEPLESS CLAMP
992019		015, 7-505 R OETIKER O/E STEPLESS CLAMP
992023		017, 0-505 R OETIKER O/E STEPLESS CLAMP
992027		018, 5-505 R OETIKER O/E STEPLESS CLAMP
992029		019, 8-505 R OETIKER O/E STEPLESS CLAMP
992031		022, 6-505 R OETIKER O/E STEPLESS CLAMP
992033		024, 1-505 R OETIKER O/E STEPLESS CLAMP
993020		25-40MM WORK DRIVE CLIP

TAPPING BOARD AND ACCESSORIES

TAPPING BOARD

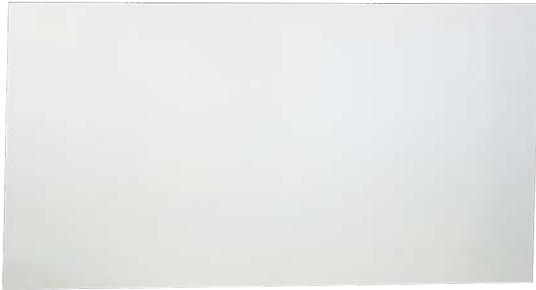

WHITE PVC TAPPING BOARD

Product Code	No.	Description
030300		TAPPING BOARD - WHITE 2440 x 1220 WHITE

TAPPING BOARD CHANNEL



Product Code	No.	Description
030335		PVC CHANNEL 155mm x 75mm
030340		PVC CHANNEL 225mm x 80mm

SADDLES



Product Code	No.	Description
030001		5mm x 1 WAY SADDLE
030002		5mm x 2 WAY SADDLE
030003		5mm x 3 WAY SADDLE
030004		5mm x 4 WAY SADDLE
030005		5mm x 5 WAY SADDLE
030006		5mm x 6 WAY SADDLE
030011		6mm x 1 WAY SADDLE
030012		6mm x 2 WAY SADDLE
030013		6mm x 3 WAY SADDLE
030014		6mm x 4 WAY SADDLE
030021		8mm x 1 WAY SADDLE
030022		8mm x 2 WAY SADDLE
030023		8mm x 3 WAY SADDLE
030024		8mm x 4 WAY SADDLE
030031		10mm x 1 WAY SADDLE
030032		10mm x 2 WAY SADDLE
030033		10mm x 3 WAY SADDLE
030034		10mm x 4 WAY SADDLE
030035		10mm x 5 WAY SADDLE
030036		10mm x 6 WAY SADDLE
030041		1/2" x 1 WAY SADDLE
030061		1" x 1 WAY SADDLE

SERVICE KITS AND 'O' RINGS

SERVICE KITS



BRUMBY TAP KIT



HOMARK FOB KIT



CELLARMAN FOB KIT



SLIDE-ON KEG COUPLER KIT



MICRO MATIC MFD KEG COUPLER KIT



CELLAR KIT
(CUSTOMISED TO SUIT YOUR NEEDS)

Product Code	No.	Description
098071		BEER GUN KIT
098241		BRUMBY TAP KIT
Z098291		PERLIC TAP 'O' KIT
Z098292		ALUMASC TAP KIT
098171		S/L KEG COUPLER KIT
098301		MICROMATIC D COUPLER KIT
098311		ANDALE KEG COUPLER KIT (BLACK PULL HANDLE)
098361		SLIDE-ON KEG COUPLER KIT
098301		COUPLER KIT - DRAFT SYSTEMS (ROUND BLUE HANDLE)
098303		COUPLER KIT - GEW (BLUE PULL HANDLE)
098321		CELLERBUOY 'O' RING KIT
098351		CELLERMAN FOB MONITOR KIT
098371		STRONGMAN FOB MONITOR KIT
098432		LINEVALVE SERVICE KIT
Z098200		SNAPLOK SERVICE KIT

Product Code	No.	Description
BS006		BS006 'O' RING
BS008		BS008 'O' RING
BS009		BS009 'O' RING
BS010		BS010 'O' RING
BS011		BS011 'O' RING
BS012		BS012 'O' RING
BS013		BS013 'O' RING
BS014		BS014 'O' RING
BS015		BS015 'O' RING
BS016		BS016 'O' RING
BS017		BS017 'O' RING
BS018		BS018 'O' RING
BS019		BS019 'O' RING
BS020		BS020 'O' RING
BS026		BS026 'O' RING
BS107		BS107 'O' RING
BS108		BS108 'O' RING
BS109		BS109 'O' RING
BS110		BS110 'O' RING
BS111		BS111 'O' RING
BS112		BS112 'O' RING
BS113		BS113 'O' RING
BS114		BS114 'O' RING
BS115		BS115 'O' RING
BS117		BS117 'O' RING
BS119		BS119 'O' RING
BS123		BS123 'O' RING
BS131		BS131 'O' RING
BS137		BS137 'O' RING
BS147		BS147 'O' RING
BS210		BS210 'O' RING
BS212		BS212 'O' RING
BS214		BS214 'O' RING
BS230		BS230 'O' RING
BS232		BS232 'O' RING
BS331		BS331 'O' RING

TOOLS OF THE TRADE

SERVICE KITS

Product Code	No.	Description
088401		HANDYMAN KEG TROLLEY
088301		KEG CHECKER
088501		REFRACTOMETER
088191		OETIKER PLIERS
088018		BRUMBY 'C' SPANNER
088141		OLIVE PUSHER - 4mm
088142		OLIVE PUSHER - MULTI



HANDYMAN KEG TROLLEY



KEG CHECKER



BRUMBY TAP BRUSH



CLEANING BRUSH



OETIKER PLIERS



BRUMBY TAP SPANNER



KLUBER GREASE



OLIVE PUSHER - 4mm to 6mm



OLIVE PUSHER - MULTI

ANDALE CARE SERVICE



For a free quote call Andale Micro Matic.

Australia's largest manufacturer, supplier and installer of beer dispensing equipment.

From preventative maintenance service to the installation of beer dispensing systems in Australia's largest stadiums, clubs and hotels, no job is too big or too small, Andale Micro Matic can do it all.

Prevent costly breakdowns and take advantage of our experienced crew and their exceptional expertise.

We can:

*Train your staff;
Look over your system to improve efficiency;
Clean your taps;
Check your gas system is safe;
Ensure your beer is chilled;
Ensure your beer is dispensed correctly;
...and many, many more cost saving measures.*

YOU CAN TRUST ANDALE MICRO MATIC

Leaders in

- Sales
- Service
- Installation

Since 1947

DEDICATED TO DRAUGHT QUALITY

Quality is key in everything we do. Based on our experience, know-how and commitment to customer service, we create state-of-the-art beer dispensing solutions, pioneer educational programs and develop creative new point-of-sale merchandising.

If you can't find what you need in the catalogue, visit your nearest Andale Micro Matic showroom to see our comprehensive range of beer dispensing equipment for yourself, or contact your nearest Andale Micro Matic outlet to discuss your beer dispensing requirements.

ANDALE-MICROMATIC.COM.AU

COMPANY ADDRESSES:

VICTORIA
Head Office
5-11 King Street,
Airport West. 3042
Tel.: +61 3 9339 6666
andalevic@andale-micromatic.com.au

NEW SOUTH WALES
2/2 Pile Road,
Somersby, 2250
Tel.: +61 2 4340 4111
andalensw@andale-micromatic.com.au

QUEENSLAND
5 Holden Street,
Woolloongabba. 4102
Tel.: +61 7 3421 5200
andaleqld@andale-micromatic.com.au

SOUTH AUSTRALIA
379 South Road,
Mile End South. 5031
Tel.: +61 8 8234 0388
andalesa@andale-micromatic.com.au

INTERNATIONAL ENQUIRIES
Tel.: +61 3 9339 6666
andalevic@andale-micromatic.com.au