

# Instructional Manual

# Rattler II Beverage Dispenser

Dispenser Model No. 950C

Please refer to the Taprite website ([www.taprite.com](http://www.taprite.com)) for information relating to Taprite installation and Service Manuals, Instruction Sheets, Technical Bulletins, Service Bulletins, etc.

PN: 805-0039G  
Rev: F  
Released: 9/28/23



#### NOTICE:

The information contained in this document is subject to change without notice.

TAPRITE MAKES NO WARRANTY OF ANY KIND WITH REGARD TO THIS MATERIAL, INCLUDING, BUT NOT LIMITED TO, THE IMPLIED WARRANTIES OF MERCHANTABILITY AND FITNESS FOR A PARTICULAR PURPOSE. TAPRITE shall not be liable for errors contained herein or for incidental consequential damages in connection with the finishings, performance, or use of this material.

This document contains proprietary information which is protected by copyright. All rights reserved.

© Copyright 2019 by Taprite, all rights reserved.

THIS DOCUMENT CONTAINS IMPORTANT INFORMATION

This manual must be read and understood before the installation and operation of this dispenser.

Taprite

3248 Northwestern Drive • San Antonio, TX 78238

Toll-Free 877.404.2488 • Fax: 210.646.6009 [www.taprite.com](http://www.taprite.com)



# TABLE OF CONTENTS

SUBJECT	PAGE NUMBER
◦ Installation	3
◦ Setting Ratio	5
◦ Flow Control Cover Installation	7
◦ Butterfly Plate and Button Removal/Reassembly	7
◦ Removing and Replacing Stem O-Ring	8
◦ Cleaning and Maintenance	11
◦ Reattaching the Bar Gun Assembly	13
◦ Troubleshooting	14
◦ Line Configuration	15
◦ Juice and Energy Butterfly Plate Configurations	16
◦ 8 and 10 Butterfly Plate Configurations	17
◦ 12 and 14 Butterfly Plate Configurations	18-19
◦ Button Plate Configurations	20
◦ Accessories	21-22
◦ Handle Assembly	23-24
◦ Manifold Assembly	25-26
◦ Flow Control Module Assembly	27-28
◦ Mechanical Module Assembly	29-30
◦ Mounting Plate Screw Placement	31
◦ Patent & Patent Pending Numbers	31
◦ Part Number Format	32
◦ APENDIX	33

## INSTALLATION

Thank you for purchasing a Taprite 950C bar dispenser. All required mounting hardware, holster assembly, and ¼" stainless-steel input fittings (with o-rings) are included with each bar dispenser. The stainless-steel input fittings are installed on the product side of the bar dispenser manifold (Fig. 1). These fittings are secured in place using the red retainer clips.



Fig. 1

### IMPORTANT

THIS EQUIPMENT MUST BE CONNECTED TO A POTABLE WATER SUPPLY AND INSTALLED WITH ADEQUATE BACK FLOW PREVENTION TO COMPLY WITH FEDERAL, STATE, AND LOCAL CODES.

Attach the base plate (smooth side out) with the provided #8 screws. Please see Page 31 for optimal screw placement.

### IMPORTANT

THE BASEPLATE PROVIDES STABILITY FOR THE BAR DISPENSER AND SHOULD BE ATTACHED TO A FLAT SURFACE. FAILURE TO INSTALL THE BAR DISPENSER AND BASEPLATE ON A FLAT SURFACE WILL VOID THE WARRANTY AND MAY CAUSE THE VALVE MODULE ASSEMBLY TO LEAK.

To install the fitting, press the barb side of the fitting into the tubing and past the last fittings barb. Secure the tubing to the fitting with an Oetiker® clamp positioned upright.

### INSTALLER TIP:

Do not install the tubing flush with the flange, this will cause the tubing to interfere with the retainer clip. Failure to install Oetikers® as shown in Figure 1 will place stress on the valve module assembly and cause a leak.

- A. If a staggered setup is necessary, input fittings are available in two additional lengths: "medium" (1.5" length), and "long" (2.7" length) (Fig. 2).

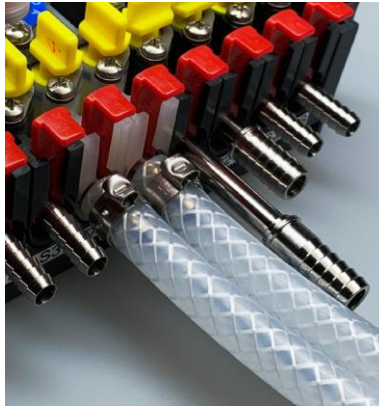

Fig. 2

- B. Follow the labeling on the assembly to ensure proper product connection.
- C. Lock inlet line fittings into the valve module assembly before turning on syrup or water. To lock the fitting, lightly press down on the red clip. Lightly pull up on the clip to allow fitting removal. (Caution: Forcibly removing the red clip from the valve body may damage the clip).



Fig. 3

- D. The bar dispenser assembly comes from the factory pre-attached to the valve module assembly. Before proceeding to the next step verify that the red retainer clips are in the locked position (down) (Fig. 3).
- E. Rotate the yellow shut-off stem 90 degrees to "Off" position to check for inlet connection leaks (Fig. 4).

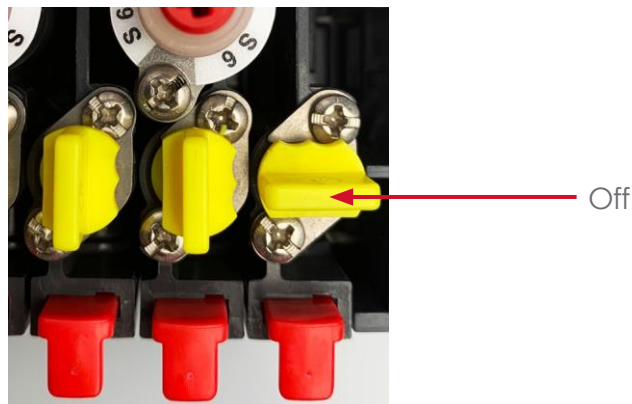

Fig. 4

- F. Slide Flow Control Module/Mechanical Module (FCM/MM) onto base plate and verify that the two bosses on the plate are lined up. Secure the manifold to the base plate with the two thumb screws.
- G. To install the holster use the screws provided. Install the holster and drain assembly in close proximity to the bar gun location. Holster mounting plate must be placed so that the release tab is accessible. Plumb the holster using 1/2" standard drain hose and follow local plumbing codes. Refer to the cleaning and maintenance section for proper removal and cleaning of holster.



Fig. 5

**IMPORTANT**

NEVER PLACE THE HOLSTER DIRECTLY OVER THE ICE BIN. HOLSTER INSERT CAN BE REMOVED AND USED WITH OTHER BAR DISPENSER HOLSTERS.

**INSTALLER TIP:**

Place your bar dispenser as close as possible to the product cooling source to minimize the dispensing of warm product and reduce foaming of the finished drinks.

**SETTING RATIO**

The Bar Dispenser has been thoroughly tested and sanitized prior to shipment. The installer will be required to set the ratio of the bar dispenser.

**INSTALLER TIP:**

Installer must cool or chill the product before setting the ratio of the system. Ratio will be different in cold product and warm product.

**IMPORTANT**

BEFORE SETTING RATIO, PURGE PRODUCT AND WATER THROUGH BAR DISPENSER TO ENSURE PROPER PRODUCT TEMPERATURE.

- A. Rotate the yellow shut-off stem to the "on" position (Fig. 4).
- B. To adjust water flow rate, press plain water button or carbonated water button on bar dispenser and capture water in a graduated cylinder or ratio cup, while timing the dispense. Divide the volume of water dispensed by the time. This will equal the flow rate in oz/s
- C. To adjust the flow, turn the red adjustment screw (Fig 6). To regulate a ceramic FCM, turn clockwise to increase flow and counterclockwise to decrease flow. If the flow control assembly contains a green adjustment screw it is a MM. To regulate flow, turn counterclockwise to increase flow and clockwise to decrease flow (opposite of ceramic flow control) (Fig. 7)

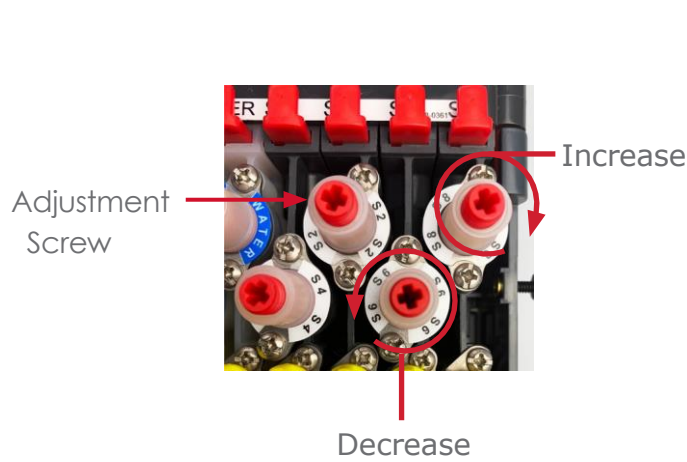

Fig. 6

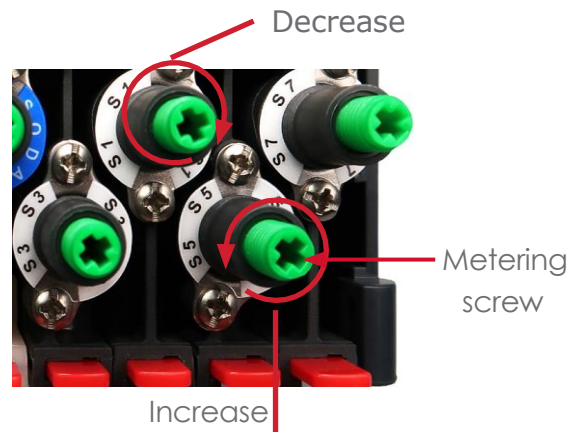

Fig. 7

**NOTE:**

The Bar Dispenser is designed to flow 1.50 oz/sec. finished drink.  
This is the proper setting for 5:1 ratio.

D. To achieve the proper water flow rate, adjust the red screw within the flow control module. For the mechanical application adjust the green metering screw (Fig. 7).

**INSTALLER TIP:**

Depending on the pressure of the incoming plain water, the maximum flow for the dispenser may not be achievable. There are two solutions to this problem.

- 1) Adjust the Brix/Ratio to account for the slower flow rate.
- 2) Add a water booster to the system.

E. To Ratio/Brix the final product, remove dispensing nozzle on bar gun assembly.

F. Replace the dispensing nozzle with the Taprite syrup separator nozzle. Line up the separator nozzle on the diffuser and turn to lock the nozzle in place. Ensure there is a tight seal against the diffuser.

G. Use a ratio cup to measure the syrup to water ratio. Adjust the flow controls to achieve the target ratio.

**INSTALLER TIP:**

The Taprite Bar Dispenser is equipped with a secondary water ratio screw that is located on the bottom of the bar dispenser handle near the nozzle (Fig. 8). This may be used to slow the flow of water to maintain proper ratio for products with ratios 1:1 or 2:1 or any high-viscosity product. The screw comes from the factory in the open position and should be used only in the conditions noted. This screw only controls water flow to the products associated with the bottom right hand butterfly plate.



Fig. 8

## FLOW CONTROL MANIFOLD COVER INSTALLATION

- A. Loosen thumb screws, located on the sides, DO NOT COMPLETELY REMOVE THUMBSCREWS. Lift the cover off the manifold.
- B. To install cover, align the slots on the cover with the thumb screws on the valve manifold assembly.
- C. Tighten thumbscrews on each side of cover. DO NOT OVERTIGHTEN.

### NOTE:

SEE "Non-Captive Stem O-Ring Service" IN THE APPENDIX for instructions on removing and replacing stem o-rings from the bottom of the handle.

## CAPTIVE O-RING DESIGN (COR)

Below are instructions for the latest revision of the Taprite bar dispenser handle. The Stem O-rings are located on top of the handle, under the button plate.

The revision includes.

1. Retainers
  - 266-0329 Retainer, O-Ring 5BRC,7BRC,8BRC,10Button
  - 266-0260 Retainer, O-Ring 12Button
  - 266-0361 Retainer, O-Ring 14Button
2. Stem, plunger
  - 265-0865 Stem, Plunger Valve BG Captive

## BUTTON AND BUTTERFLY PLATE REMOVAL/RE-ASSEMBLY

The Taprite Bar Dispenser handle can be configured into numerous combinations of carbonated and non-carbonated products. All combinations can be made without shutting down the system.

Begin by removing the (2) 6-32x0.5" button plate screws located on top of the handle, do not discard, see [Fig. 9](#) below.

- A. To change the butterfly plate(s). Remove the (2) 6-32x.0375" screws and (2) butterfly (black)retainers, [Fig.10](#).
- B. Remove butterfly plates from handle [Fig. 11](#), save screws and butterfly retainers for re-installing.
- C. Ensure that the o-ring retainer(s), [Fig. 12](#), below the butterfly plates, are correctly in place before replacing butterfly plates as required.

### INSTALLER TIP:

Verify the O-Rings are seated properly and add lubricant before re-installing components, see instructions on Removing and Replacing Stem O-Ring.

- D. Align the pivot balls, at the bottom of the butterfly plates, with the divots in the o-ring retainer.
- E. Secure butterfly plate(s). Use the (2) 6-32x.0375" screws and (2) butterfly (black)retainers. DO NOT OVERTIGHTEN.
- F. Replace button plate and re-attach with the (2) 6-32x0.5".

## REMOVING AND REPLACING STEM O-RING

### NOTE:

The new retainer design allows one to service and replace the stem O-rings without the need to remove the bottom plate.

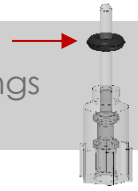

The Stem O-rings are located on top of the handle, under the button plate.

Begin by shutting off pressure. Rotate the (yellow) shut-off stem(s) 90 degrees counterclockwise on the valve manifold, **Fig.4**.

- A. Press the buttons on the handle to release any pressure.
- B. Remove the button and the butterfly plates, see instructions **Button and Butterfly Plate Removal/Re-Assembly**.



Fig. 9

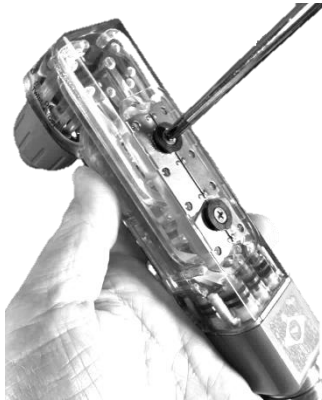

Fig. 10



Fig. 11

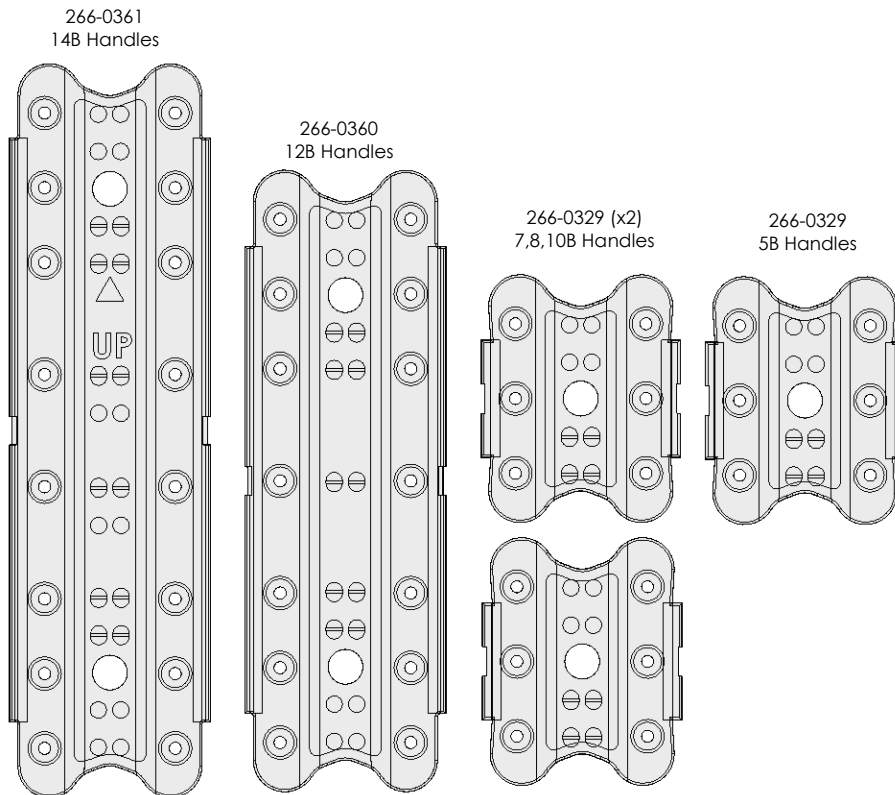

Fig.12



- C. Remove O-Ring retainer by tilting the handle upside down, **Fig.13**. If retainer(s) does not fall out, carefully lift the clear retainer straight up by lightly applying outwards pressure with your fingers on the tabs of the retainer, see **Fig. 14**, and slowly guide up through the plunger stem(s). Inspect retainer for wear or cracks replace if damaged.

**NOTE:**

During removal, retainer(s) should have little to no resistance when guided evenly off the surface of the handle. The plunger stems will restrict the movement of the retainer if angled too much.

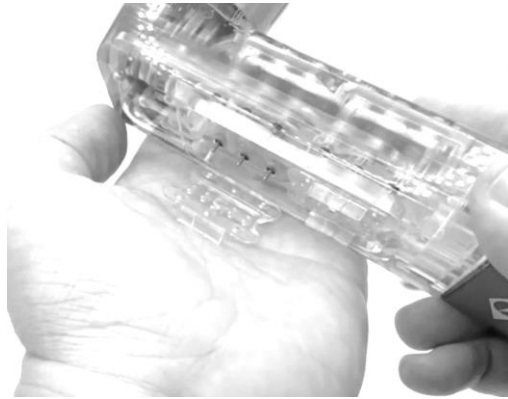

**Fig.13**

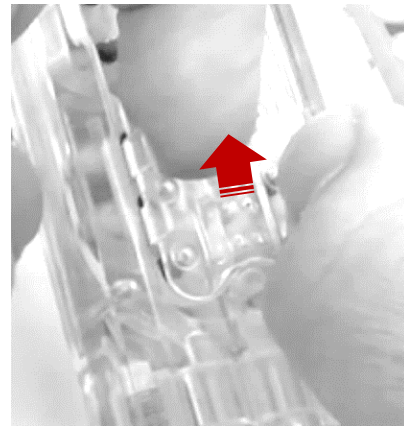
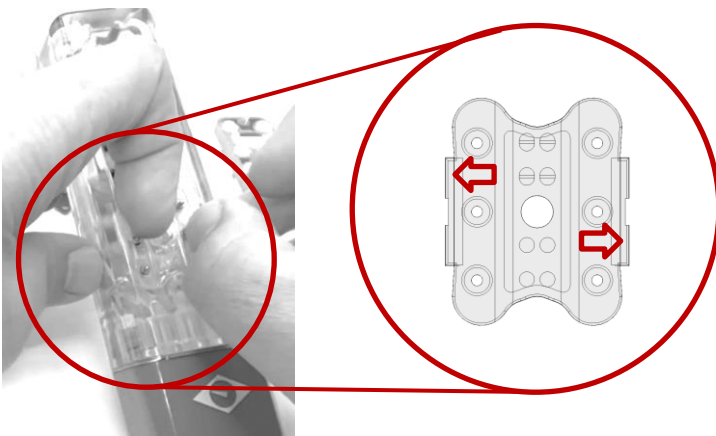

**Fig.14**

- D. Using the O-ring tool, PN 316-0028, carefully remove the O-ring(s) that need to be replaced, **Fig. 15**. **Be careful not to damage the O-ring gland as this may lead to leaks.**



**Fig. 15**

E. Insert the lubricated replacement O-ring, PN 208-5003, over the plunger stem and install into the bottom of the gland using the PN 316-0028 O-ring insert tool, Fig. 16.

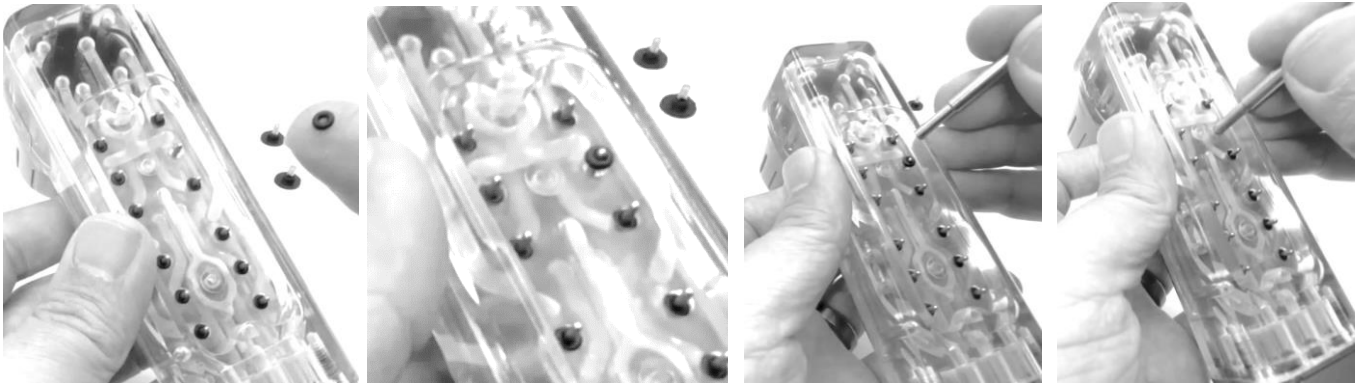

Fig. 16

**NOTE:**

Failure to shut off flow to the handle may result in a high-pressure blast of water or syrup to be shot out of the o-ring gland if plunger stem is accidentally depressed.

F. Replace the retainer(s) by aligning the holes over the stem plunger and slide down onto the handle, see Fig. 17.

The oval divots in PN 266-0329 are designed to face towards the center of the handle, see Fig. 18. However, orientation of the retainers is only critical on 14B handles (266-0361 retainer), which is why there is an up arrow indicating the proper orientation, see Fig. 12.



Fig. 17

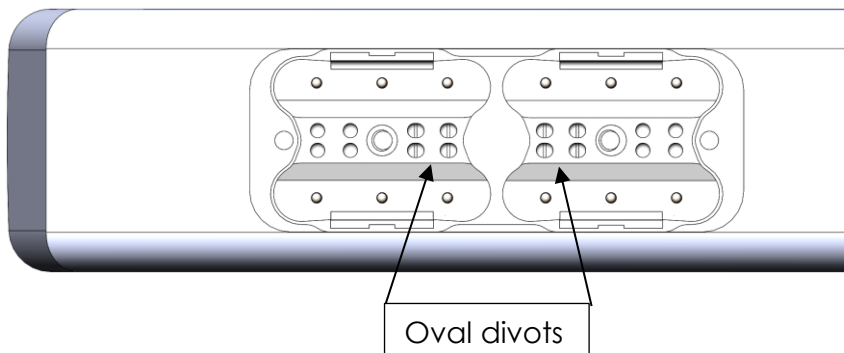

Fig. 18

G. Assemble the butterfly plates and retainer, fasten to **2.5 inlb max.**



**Do not over tighten**

**IMPORTANT:**

Exceeding the max torque on the butterfly screws may impede proper function of the butterfly plate(s) and can strip threads on the handle.

H. Replace button plate, see **Fig 9.**

**CLEANING AND MAINTENANCE**

The Bar Dispenser is shipped from the factory cleaned and sanitized in accordance with NSF guidelines. The bar dispenser must also be cleaned and sanitized after installation is complete. It is recommended that the operator provide continuous maintenance as required by the manual and/or state and local guidelines to ensure proper operation.

**IMPORTANT**

DO NOT CLEAN WITH OR ALLOW CONTACT WITH HARSH CHEMICALS CONTAINING ATBC (ACETYL TRIBUTYL CITRATE) OR OTHER ORGANIC SOLVENTS (CLEANER/DEGREASERS, PESTICIDES AND PESTICIDE FOGGERS). THIS WILL CAUSE PERMANENT DAMAGE TO PLASTIC COMPONENTS.

DO NOT SUBMERGE THE HANDLE IN HOT WATER. THIS WILL CAUSE PERMANENT DAMAGE TO THE DISPENSER AND ITS COMPONENTS.

A. External Cleaning

Cleaners (ivory liquid, calgon, etc.) should be mixed with clean potable water at a temperature of 90 to 110 degrees F. The acceptable mixture ratio is one ounce of cleanser to two gallons of water. Any NSF approved equivalent cleaner may be used. Rinse with clean potable water.

**IMPORTANT**

ONLY USE INTERNAL CLEANING SOLUTIONS THAT ARE APPROVED FOR BEVERAGE DISPENSER APPLICATIONS, SUCH AS KAY-5®. (NO CAUSTIC CHEMICALS SUCH AS INDUSTRIAL KITCHEN CLEANING CHEMICALS SHOULD EVER BE USED)

B. Sanitizing

Sanitizing solutions must provide 50 to 100 parts per million (PPM) available chlorine. Any sanitizing solution may be used as long as it is prepared in accordance with the manufacturer's recommendations.

### C. Daily Cleaning

#### 1. Dispenser Handle

- a. Prepare sanitizing solution.
- b. Remove nozzle by twisting counterclockwise and pulling down and submerging nozzle into a sanitizing solution for 15 minutes. The diffuser is not removable.

#### NOTE:

Diffuser is **NOT** removable, attempting to remove diffuser may damage dispenser

#### c. Wash diffuser and sanitize:

- i. Use Nozzle Sanitizing Assy. (PN 631-0187) accessory: Fill nozzle with sanitizing solution and install onto diffuser by twisting clockwise while pushing up onto diffuser. Leave on for 15 minutes.
- ii. Or, if Sanitizing Nozzle Assy. is not utilized, wash diffuser, rinse and immerse the diffuser **only** in sanitizing solution for 15 minutes.

#### NOTE:

DO **NOT** submerge handle assembly into sanitizing solution!!

- d. Remove diffuser and nozzle from sanitizing solution, air dry. Reinstall nozzle on diffuser.

### D. Deep Cleaning of Bar Dispenser Whip

1. Rotate yellow Shut-off stem 90 degrees to turn off water/product (Fig. 19).
2. Turn the two (2) wing screws to release the FCM/MM from the base plate (Fig 20).
3. Slide FCM/MM module out of mounting plate.
4. Snap the red retainer clips to the open position (Fig 21).
5. Locate the two slotted red screw separators on the outside of the bar gun manifold and turn the screws clockwise. This will separate the bar gun dispenser from the FCM/MM module (Fig. 22).

#### NOTE:

Alternate turning red screw separator to evenly remove the bar gun manifold from the module. The Shut-off tool (P.N. 316-0005), or a screw driver, can be used to aid in removing the dispenser assembly but is not necessary.

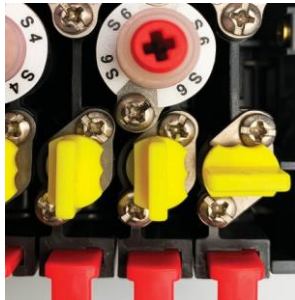

Fig.19

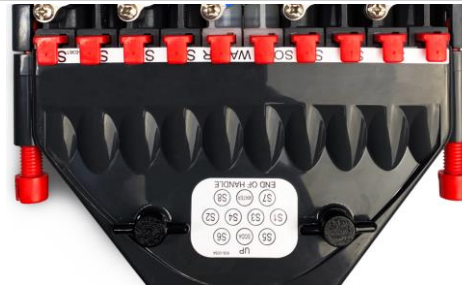
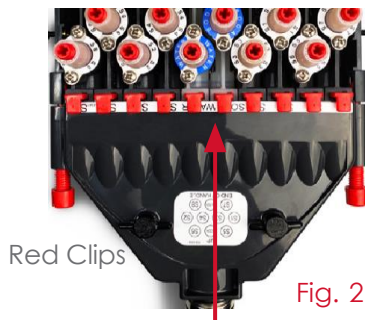

Fig.20



Red Clips

Fig. 21

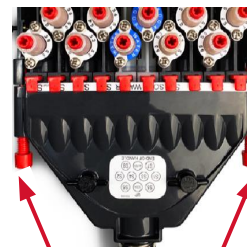

Fig. 22

Screws

6. Fill a bar sink or a 5 gal. bucket with sanitizing solution that is mixed to mfg. recommendations (50 to 100 PPM). Allow the bar gun whip assembly to soak in the solution for 10 to 15 minutes. Using a cloth and brush, wash and clean the hose. Inspect the hose to ensure all residue is removed. It should not be soaked overnight.
7. Rinse with warm water and allow to dry.

#### E. Holster Cleaning

##### 1. Daily Cleaning

For daily cleaning, press carbonated water button or water button on bar handle while sitting in the holster to flush product residue down drain. You may also pour warm water down the receptacle to clean holster.

##### 2. Bi-weekly Cleaning

- a. To remove holster assembly, push tab located behind the nozzle receptacle. Slide holster assembly forward (toward you) (Fig. 23-24).
- b. Separate the bar gun receptacle from the drip tray (Fig. 25).
- c. Refer to sanitizing section in 3-B.

Fig. 23



Fig. 24



Fig. 25



#### NOTE:

Check the back of the drip tray drain connector to ensure there is no damage to the o-rings (P.N. 208-5112-429) (Fig. 25)

#### REATTACHING THE BAR GUN WHIP ASSEMBLY

- A. Adjust the red screw separators on the outside of the bar gun assembly so the small smooth shank is exposed.
- B. Slide the bar gun manifold into the FCM/MM module.
- C. Snap red retainers into the locked position.
- D. Slide FCM/MM module and bar dispenser into locked position on mounting plate and secure with wing screws
- E. Rotate yellow Shut-off stem 90 degrees to the open position and check for leaks.
- F. Depress all buttons on bar dispenser head to remove any trapped air or sanitizing solution.
- G. Bar Dispenser is ready for operation.

## TROUBLE SHOOTING

- A. Push water - no water dispensed
  - Check water supply
  - Check Shut-off (is it open)
  - Check ratio/brix adjustment
  - Check for proper butterfly plate
- B. Push syrup - no syrup dispensed
  - Check CO<sub>2</sub> pressure
  - Check for product
  - Check Shut-off
  - Check ratio/brix adjustment
  - Line plugged
- C. Push soda - no soda dispensed
  - Check carbonator
  - Check water supply
  - Check CO<sub>2</sub> pressure
  - Check Shut-off
  - Check ratio/brix adjustment
  - Check for proper butterfly plate
- D. Push product - dispensing incorrect product
  - Check for proper plumbing
  - Check for proper butterfly plate
- E. Weak product taste
  - Check syrup CO<sub>2</sub> supply
  - Check ratio/brix adjustment
  - Check for plugged line
  - Check Shut-off - open completely
  - Check syrup supply
- F. Strong product taste
  - Check ratio/brix adjustment
  - Check carbonator pressure
  - Check syrup CO<sub>2</sub>
- G. Continuous dispense
  - Check butterfly plates - damaged or too tight
  - Check for debris in syrup or water passages
- H. Product leaking from bottom plate
  - Defective stem o-ring
  - Bottom plate screws are loose
  - Warped or damaged bottom plate

# LINE CONFIGURATION

## 8 Button

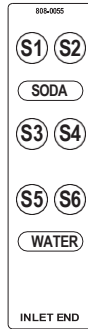
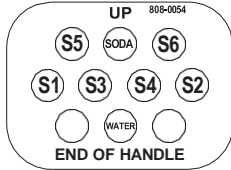

## 10 Button

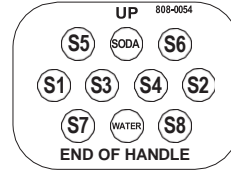

## 12 Button

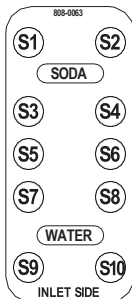
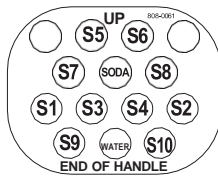

## 14 Button

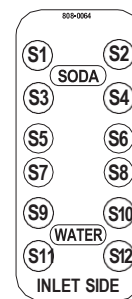
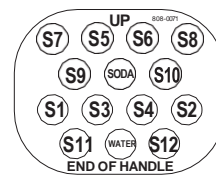

# JUICE AND ENERGY BUTTERFLY PLATE CONFIGURATION

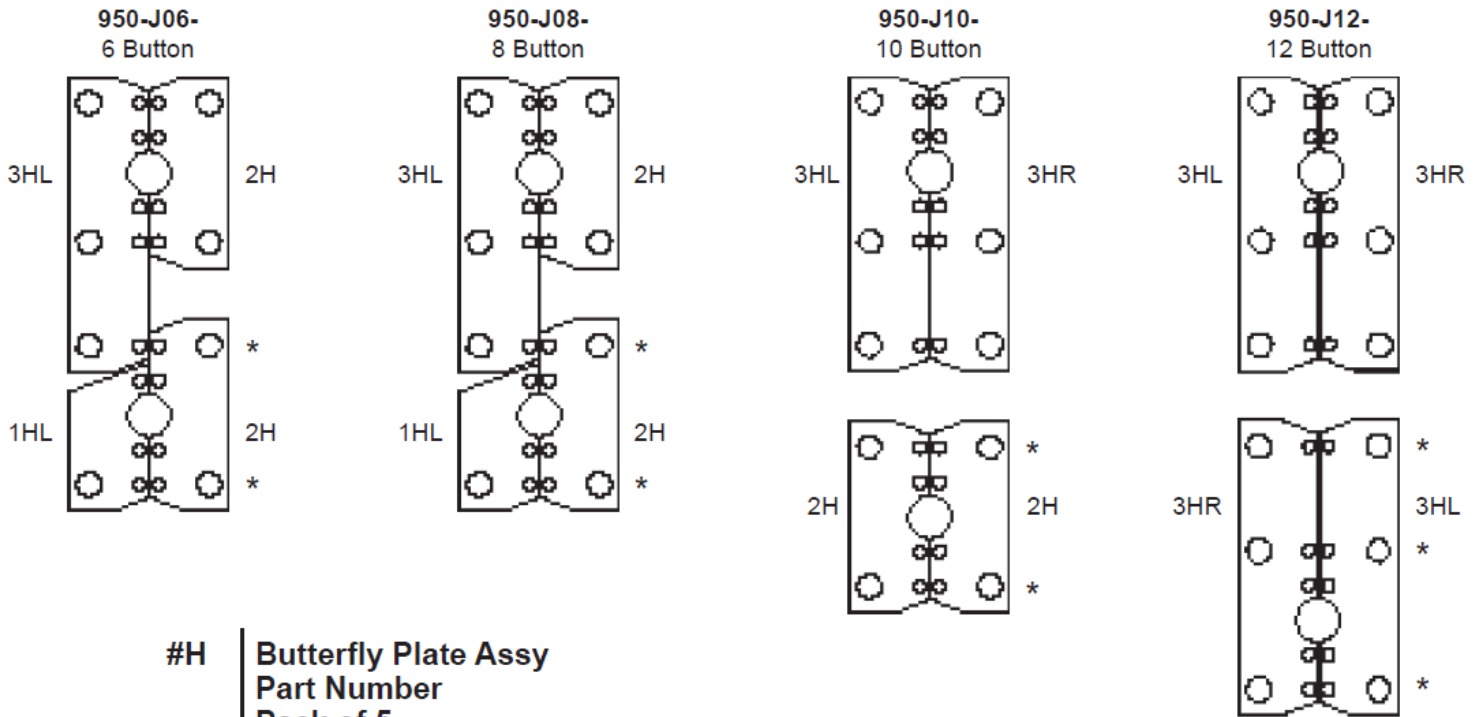

#H	Butterfly Plate Assy Part Number Pack of 5
1HL	634-0001-SP
1HR	634-0002-SP
2H	634-0003-SP
3HL	634-0004-SP
3HR	634-0005-SP
4HL	634-0006-SP
4HR	634-0007-SP
4H#3	634-0008-SP
4H#4	634-0009-SP

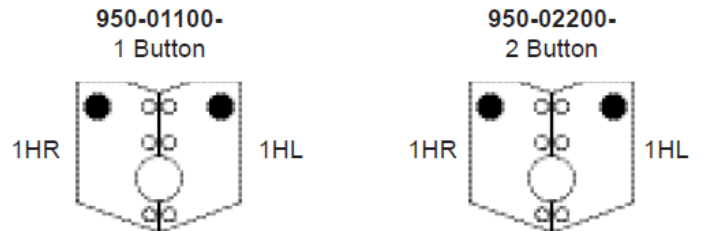

● = Carbonated Positions  
○ = Non-Carbonated Positions

\* = Secondary Water Metering Screw Affects These Positions  
Ⓜ = Requires Soda/Water Button Foot (P.N. 265-0039/265-0040) Extensions Into Bottom Of Button Where Symbol Appears.



# 8 AND 10 BUTTON BUTTERFLY PLATE CONFIGURATIONS

**950-10800-**  
 8 Button Carbonated  
 0 Button Non-Carbonated  
 0 Pre-Mix

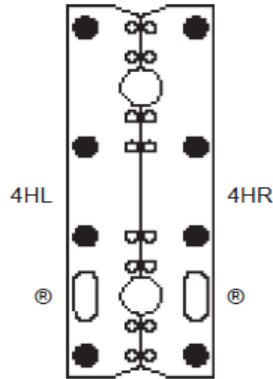

**950-10710-**  
 7 Button Carbonated  
 1 Button Non-Carbonated  
 0 Pre-Mix

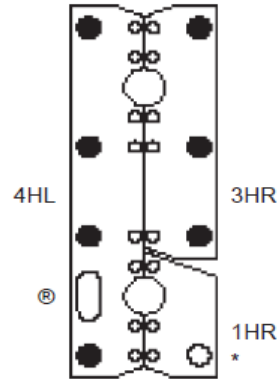

**950-10620- & 950-08600-**  
 6 Button Carbonated  
 2 Button Non-Carbonated  
 0 Pre-Mix

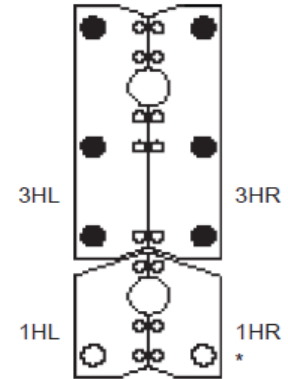

**950-10530- & 950-08510-**  
 5 Button Carbonated  
 3 Button Non-Carbonated  
 0 Pre-Mix

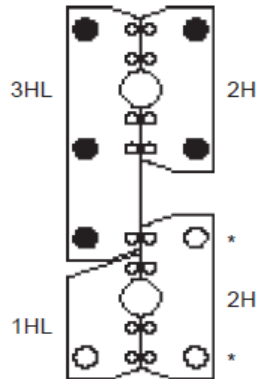

**950-10440-**  
 4 Button Carbonated  
 4 Button Non-Carbonated  
 0 Pre-Mix

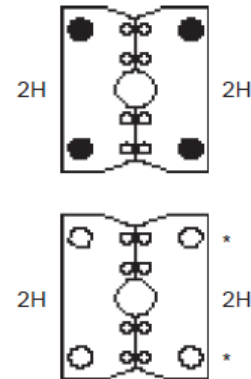

**950-10350-**  
 3 Button Carbonated  
 5 Button Non-Carbonated  
 0 Pre-Mix

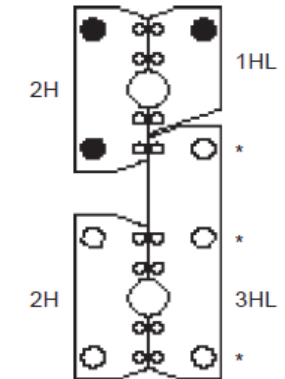

**950-10260-**  
 2 Button Carbonated  
 6 Button Non-Carbonated  
 0 Pre-Mix

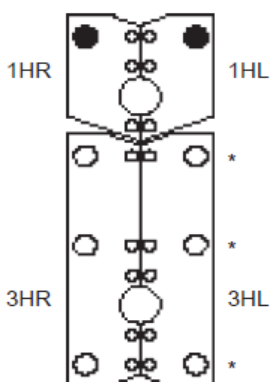

**950-10170-**  
 1 Button Carbonated  
 7 Button Non-Carbonated  
 0 Pre-Mix

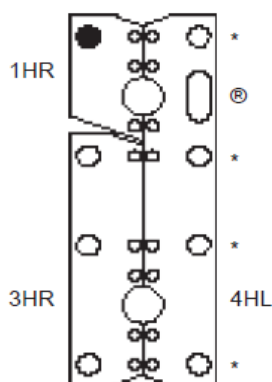

**950-10080-**  
 0 Button Carbonated  
 8 Button Non-Carbonated  
 0 Pre-Mix

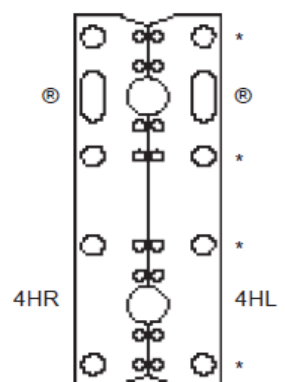

● = Carbonated Positions  
 ○ = Non-Carbonated Positions  
 #H = See Chart on Page 12 for Part Number

\* = Secondary Water Metering Screw Affects These Positions  
 Ⓜ = Requires Soda/Water Button Foot (P.N. 265-0039/265-0040)  
 Extensions Into Bottom Of Button Where Symbol Appears.

# 12 AND 14 BUTTON BUTTERFLY PLATE CONFIGURATIONS

**950-12820-**  
 8 Button Carbonated  
 2 Button Non-Carbonated  
 0 Pre-Mix

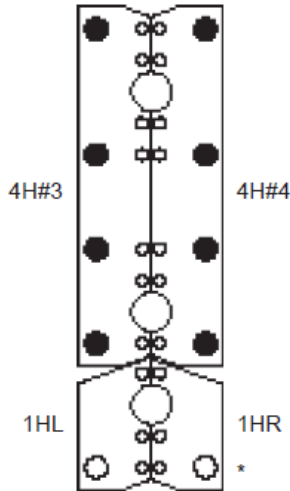

**950-12730-**  
 7 Button Carbonated  
 3 Button Non-Carbonated  
 0 Pre-Mix

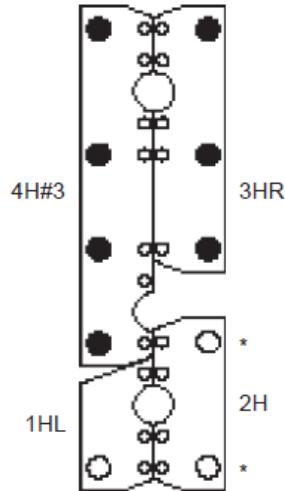

**950-12640-**  
 6 Button Carbonated  
 4 Button Non-Carbonated  
 0 Pre-Mix

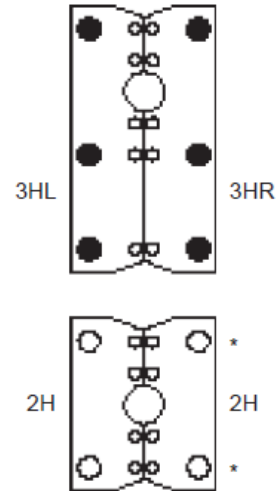

**950-12550-**  
 5 Button Carbonated  
 5 Button Non-Carbonated  
 0 Pre-Mix

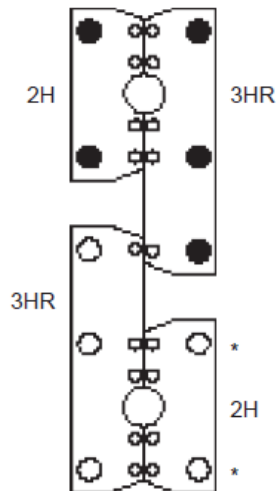

**950-12460-**  
 4 Button Carbonated  
 6 Button Non-Carbonated  
 0 Pre-Mix

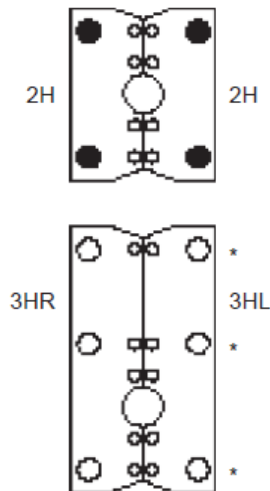

**950-12370-**  
 3 Button Carbonated  
 7 Button Non-Carbonated  
 0 Pre-Mix

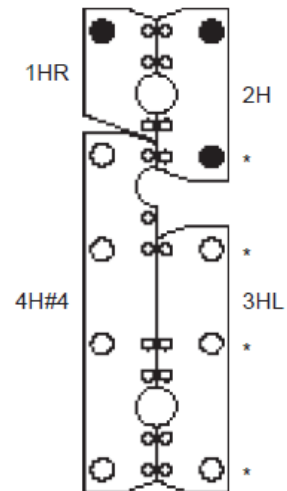

● = Carbonated Positions  
 ○ = Non-Carbonated Positions  
 #H = See Chart on Page 12 for Part Number

\* = Secondary Water Metering Screw Affects These Positions  
 ⊙ = Requires Soda/Water Button Foot (P.N. 265-0039/265-0040)  
 Extensions Into Bottom Of Button Where Symbol Appears.

# 12 AND 14 BUTTON BUTTERFLY PLATE CONFIGURATIONS

**950-12280-**  
 2 Button Carbonated  
 8 Button Non-Carbonated  
 0 Pre-Mix

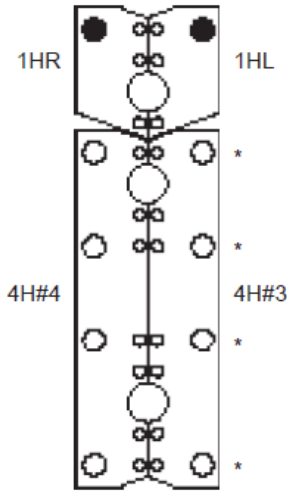

**950-14840-**  
 8 Button Carbonated  
 4 Button Non-Carbonated  
 0 Pre-Mix

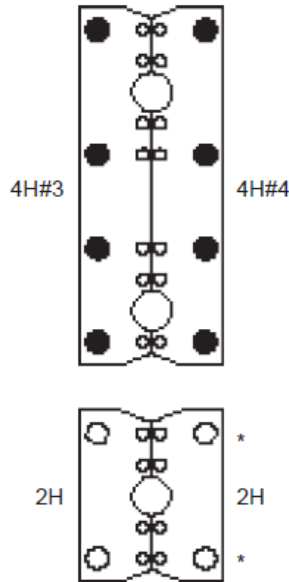

**950-14750-**  
 7 Button Carbonated  
 5 Button Non-Carbonated  
 0 Pre-Mix

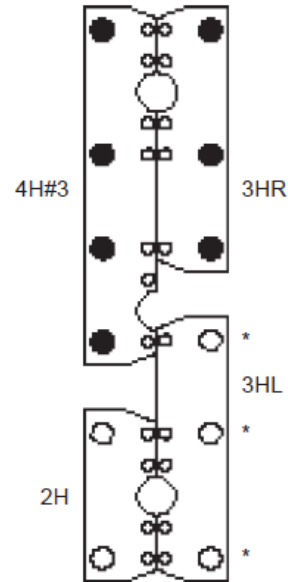

**950-14660-**  
 6 Button Carbonated  
 6 Button Non-Carbonated  
 0 Pre-Mix

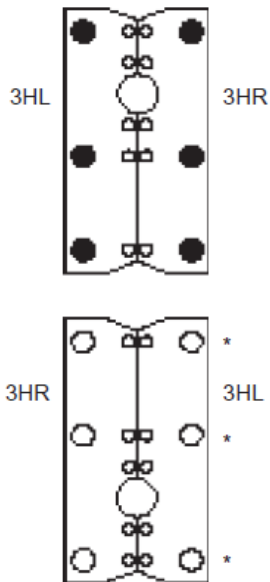

**950-14570-**  
 5 Button Carbonated  
 7 Button Non-Carbonated  
 0 Pre-Mix

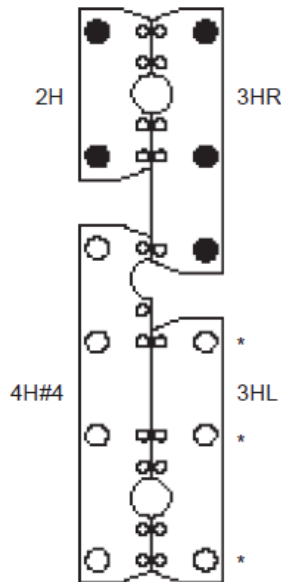

**950-14480-**  
 4 Button Carbonated  
 8 Button Non-Carbonated  
 0 Pre-Mix

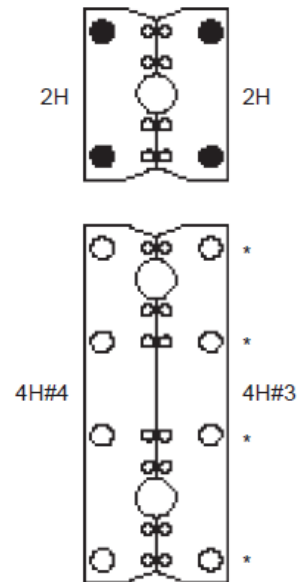

● = Carbonated Positions  
 ○ = Non-Carbonated Positions  
 #H = See Chart on Page 12 for Part Number

\* = Secondary Water Metering Screw Affects These Positions  
 © = Requires Soda/Water Button Foot (P.N. 265-0039/265-0040)  
 Extensions Into Bottom Of Button Where Symbol Appears.

# BUTTON PLATE CONFIGURATIONS

015



**659-0015**  
8 BUTTON  
6C/0NC

014



**659-0014**  
10 BUTTON  
5C/3NC, 6C/2NC, 8C/0N

019



**659-0019**  
12 BUTTON  
6C/4NC, 7C/3NC

020



**659-0020**  
14 BUTTON  
6C/6NC, 8C/4NC

PLEASE CONTACT CUSTOMER SERVICE FOR OTHER PLATE CONFIGURATIONS

# ACCESSORIES

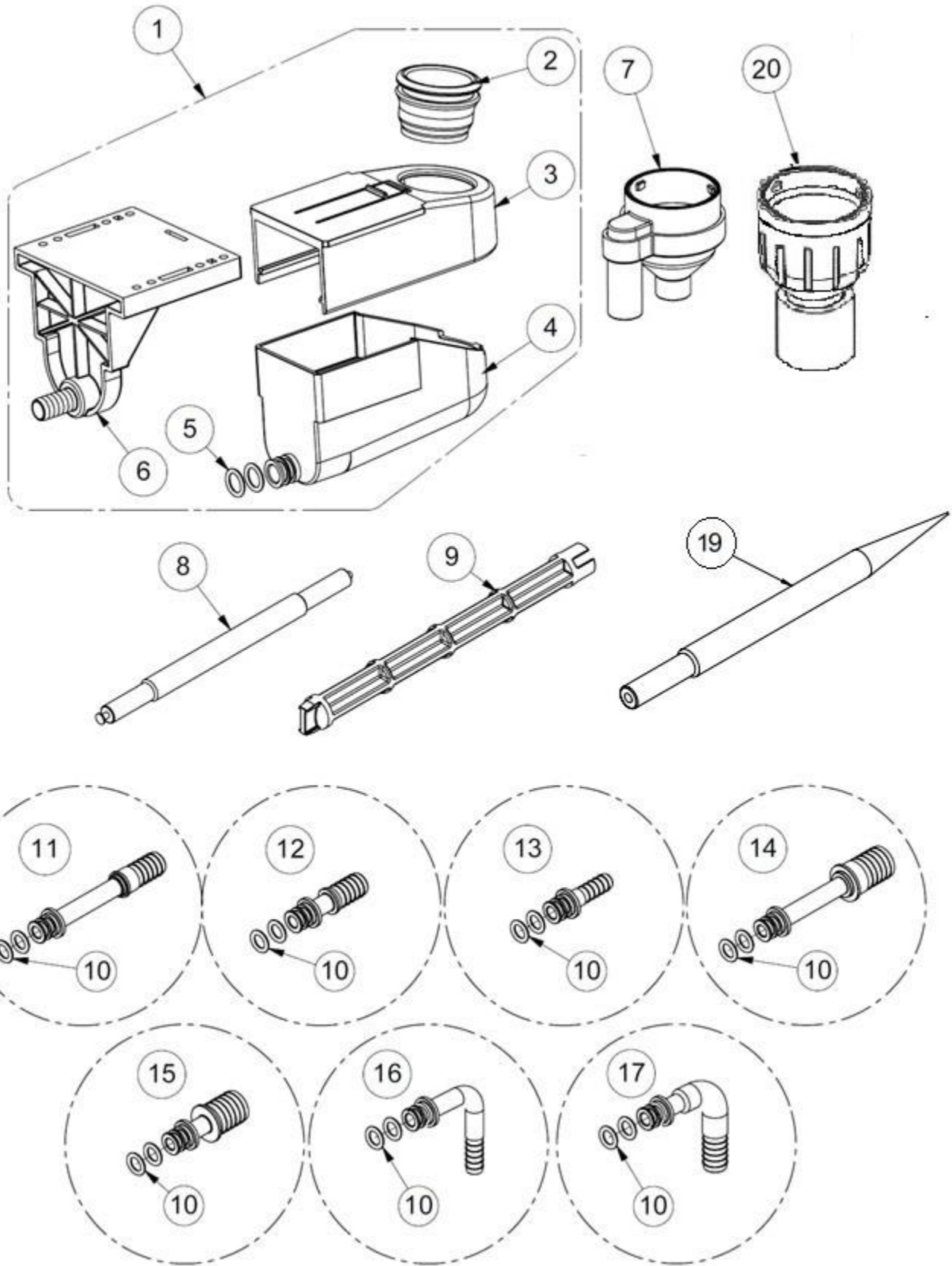

# ACCESSORIES

<b>ACCESSORIES PARTS LIST</b>		
<b>ITEM</b>	<b>TAPRITE PN</b>	<b>DESCRIPTION</b>
1	675-0017-SP	KIT, HOLSTER ASSY, W/SCREWS/BG, BLACK, 5/PK
2	315-0016	INSERT, HOLSTER, SHORT, BARGUN
3	265-0151	HOLSTER, BARGUN, BLACK
4	265-0152	DRIPTRAY, BARGUN, BLACK
5	208-5112-SP	KIT, O-RING, 2-112, EPDM, 100/PK
6	265-0153	BRACKET, MOUNTING, BARGUN, BLACK
7	316-0004-SP	SEPARATOR, BARGUN, 5/PK
8	316-0003-SP	TOOL, INSERT/EXTRACTOR, O-RING, 5/PK
9	316-0005-SP	TOOL, SHUTOFF, 5/PK
10	208-5010-SP	KIT, O-RING, 2-010, EPDM, 100/PK
11	625-0065-SP	KIT, FITTING ASSY, 3/8 BARB x 2.70"L, W/FLANGE, 25/PK
12	625-0066-SP	KIT, FITTING ASSY, 3/8 BARB x 1.50"L, W/FLANGE, 25/PK
13	625-0067-SP	KIT, FITTING ASSY, 1/4 BARB x 1.25"L, W/FLANGE, 25/PK
14	625-0068-SP	KIT, FITTING ASSY, 1/2 BARB x 2.70"L, W/FLANGE, 25/PK
15	625-0069-SP	KIT, FITTING ASSY, 1/2 BARB x 1.50"L, W/FLANGE, 25/PK
16	625-0070-SP	KIT, FITTING ASSY, 1/4 BARB, ELBOW, W/FLANGE, 25/PK
17	625-0071-SP	KIT, FITTING ASSY, 3/8 BARB, ELBOW, W/FLANGE, 25/PK
18	030-0017	DRAIN TUBE, BARGUN (NOT SHOWN)
19	316-0028	CAPTIVE O-RING FIELD INSTALL TOOL
20	631-0187-SP	NOZZLE ASSY, PLUGGED, SANITIZING, 25/PK

# HANDLE ASSEMBLY

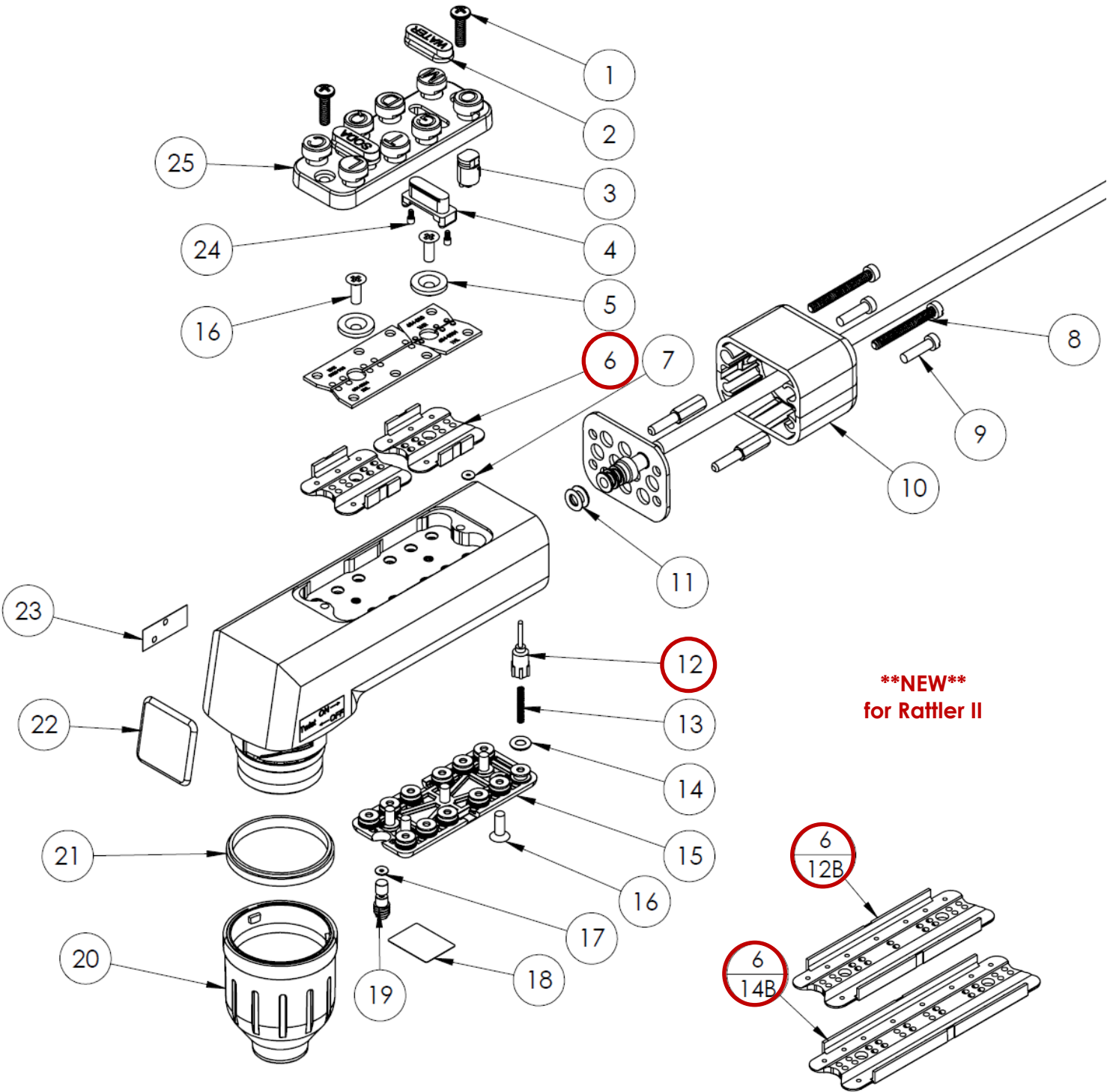

# HANDLE ASSEMBLY

BARGUN HANDLE PARTS LIST		
ITEM	TAPRITE PN	DESCRIPTION
1	220-0012-SP	KIT, SCREW, 6-32 x .500, PH, PHD, SS, 50/PK
2	265-0039-SP	KIT, BUTTON, WATER, OVAL, 50/PK
	265-0040-SP	KIT, BUTTON, SODA, OVAL, 50/PK
3	265-0007-SP	KIT, ACTUATOR, SINGLE, 50/PK
	265-0083-SP	KIT, ACTUATOR, SINGLE, PREMIX, 50/PK
4	265-0004-SP	KIT, ACTUATOR, WATER/SODA, 50/PK
5	265-0001-SP	KIT, RETAINER, BUTTERFLY, 100/PK
6	266-0329-SP	KIT, RETAINER, O-RING, 5B, 7B, 8B, 10B BGN, CAPTIVE, 10/PK
	266-0360-SP	KIT, RETAINER, O-RING, 12B BGN, CAPTIVE, 5/PK
	266-0361-SP	KIT, RETAINER, O-RING, 14B BGN, CAPTIVE, 5/PK
7	208-5003-SP	KIT, O-RING, 2-003, EPDM, 100/PK
8	220-0009-SP	KIT, SCREW, 6-32 x 1.125, SL, FHD, SS, (3B, 5B, 10B), 100/PK
	220-0015-SP	KIT, SCREW, 6-32 x 1.562, SL, FHD, SS, (12B, 14B), 100/PK
9	220-0010-SP	KIT, SCREW, 6-32 x .500, SL, FHD, SS 100/PK
10	631-0028-SP	KIT, HEEL ASSY, HANDLE, 6B, BLACK, 5/PK
	631-0010-SP	KIT, HEEL ASSY, HANDLE, 8/10B, BLACK, 5/PK
	631-0023-SP	KIT, HEEL ASSY, HANDLE, 12/14B, BLACK, 5/PK
11	208-5008-SP	KIT, O-RING, 2-008, EPDM, 100/PK
12	265-0865-SP	KIT, STEM, PLUNGER, VALVE BG, CAPTIVE, 25/PK
13	215-0001-SP	KIT, SPRING, STEM, 25/PK
14	208-5007-SP	KIT, O-RING, 2-007, EPDM, 100/PK
15	645-0065-SP	KIT, PLATE ASSY, PLUNGER, RETAINER, 6B, BLACK, 5/PK
	645-0011-SP	KIT, PLATE ASSY, PLUNGER, RETAINER, 8/10B, BLACK, 5/PK
	645-0068-SP	KIT, PLATE ASSY, PLUNGER, RETAINER, 12B, BLACK, 5/PK
	645-0071-SP	KIT, PLATE ASSY, PLUNGER, RETAINER, 14B, BLACK, 5/PK
16	220-0001-SP	KIT, SCREW, 6-32 x .375, 100 DEG FHP, 100/PK
18	808-0018-SP	KIT, LABEL, PLATE, BOTTOM, 50/PK
17	208-5003-SP	KIT, O-RING, 2-003, EPDM, 100/PK
19	625-0001-SP	KIT, SCREW ASSY, WATER, BRIX, 25/PK
20	265-0194-SP	KIT, BODY, NOZZLE, BLACK, 5/PK
21	210-0006-SP	KIT, SEAL, HANDLE, 5/PK
22	808-0074-SP	KIT, LABEL, DOMED, BG, GENERAL BEVERAGE, 8/SHEET
23	808-0278-SP	KIT, LABEL, TWIST-ON, BARGUN, 25/PK
24	279-0014-SP	KIT, EXTENSION, ACTUATOR, WATER/SODA, 100/PK
25	265-0205-SP	KIT, PLATE, BUTTON, 6B, JUICE, BLACK, 5/PK
	265-0196-SP	KIT, PLATE, BUTTON, 8B, BLACK, 5/PK
	265-0202-SP	KIT, PLATE, BUTTON, 8B, JUICE, BLACK, 5/PK
	265-0009-SP	KIT, PLATE, BUTTON, 10B, BLACK, 5/PK
	265-0089-SP	KIT, PLATE, BUTTON, 12B, BLACK, 5/PK
	265-0092-SP	KIT, PLATE, BUTTON, 14B, BLACK, 5-PK



# MANIFOLD ASSEMBLY

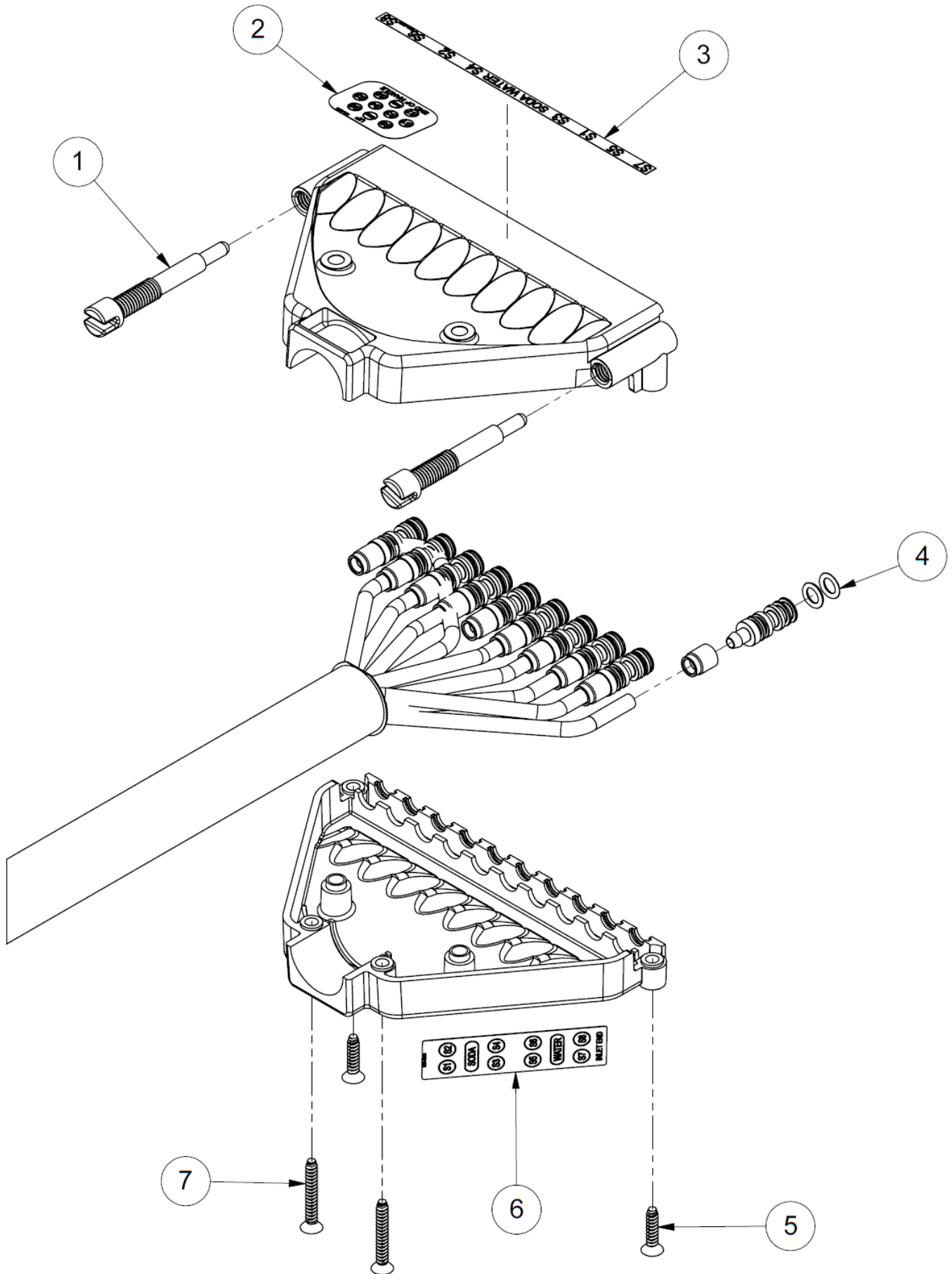

# MANIFOLD ASSEMBLY

<b>BARGUN MANIFOLD PARTS LIST</b>		
<b>ITEM</b>	<b>TAPRITE PN</b>	<b>DESCRIPTION</b>
1	265-0076-SP	KIT, SCREW, SEPARATOR, 10/PK
2	808-0173-SP	KIT, LABEL, HANDLE LAYOUT, 8B, 5/PK
	808-0054-SP	KIT, LABEL, HANDLE LAYOUT, 10B, 5/PK
	808-0061-SP	KIT, LABEL, HANDLE LAYOUT, 12B, 5/PK
	808-0071-SP	KIT, LABEL, HANDLE LAYOUT, 14B, 5/PK
3	808-0175-SP	KIT, LABEL, HOUSING LAYOUT, 8B, COMPACT BG, 4/PK
	808-0361-SP	KIT, LABEL, HOUSING LAYOUT, 10B, COMPACT BG, 4/PK
	808-0362-SP	KIT, LABEL, HOUSING LAYOUT, 12B, COMPACT BG, 4/PK
	808-0384-SP	KIT, LABEL, HOUSING LAYOUT, 14B, COMPACT BG, 4/PK
4	208-5010-SP	KIT, O-RING, 2-010, EPDM, 100/PK
5	224-0019-SP	KIT, SCREW, 8-16 x .688, PH, FHD, PLS, SS, 100/PK
6	808-0174-SP	KIT, LABEL, BUTTON LAYOUT, 8B, 5/PK
	808-0055-SP	KIT, LABEL, BUTTON LAYOUT, 10B, 5/PK
	808-0063-SP	KIT, LABEL, BUTTON LAYOUT, 12B, 5/PK
	808-0064-SP	KIT, LABEL, BUTTON LAYOUT, 14B, 5/PK
7	224-0018-SP	KIT, SCREW, 8-16 x 1.125, PH, FHD, PLS, SS, 100/PK

# FLOW CONTROL MODULE ASSEMBLY

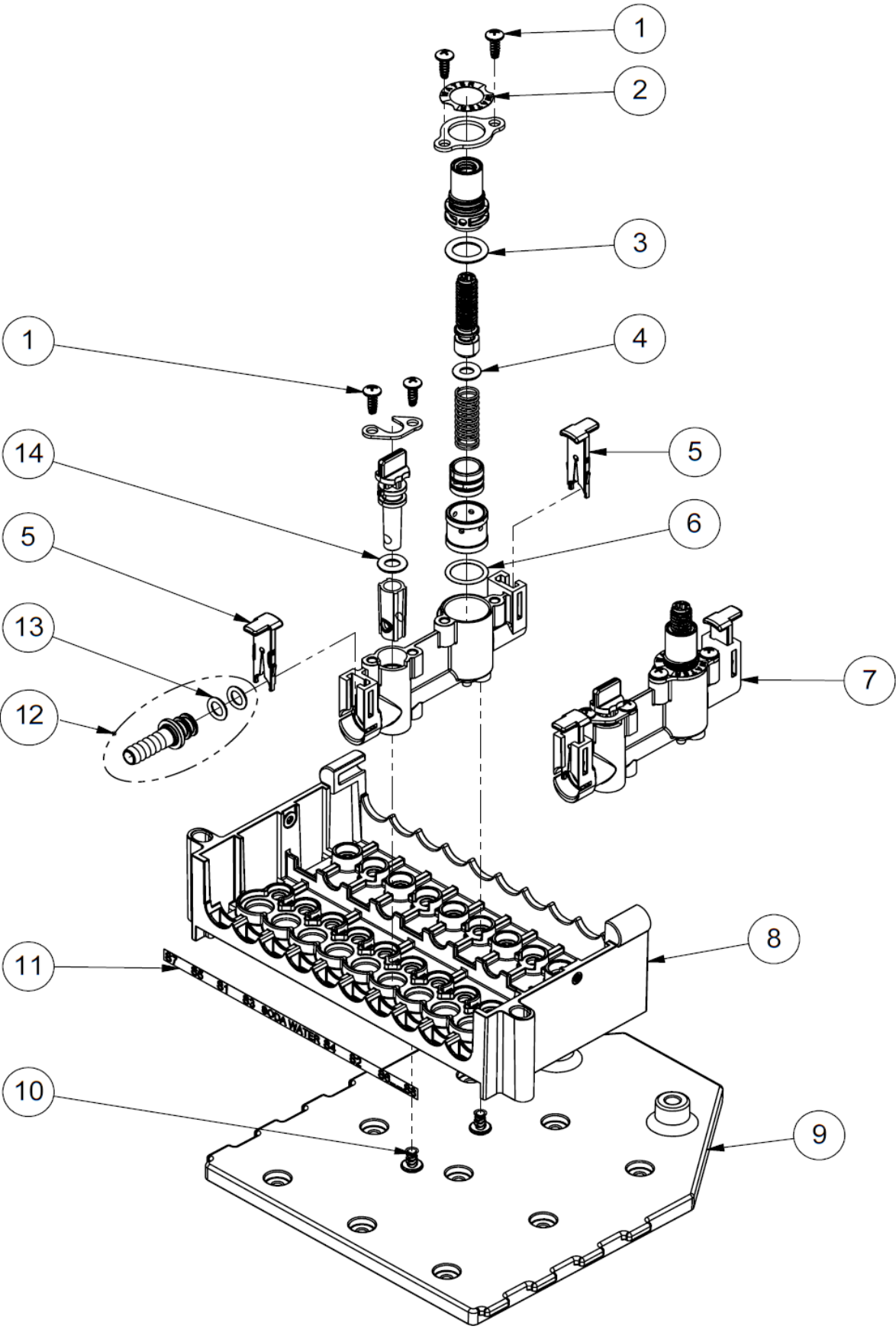

# FLOW CONTROL MODULE ASSEMBLY

<b>BARGUN FLOW CONTROL MODULE PARTS LIST</b>		
<b>ITEM</b>	<b>TAPRITE PN</b>	<b>DESCRIPTION</b>
1	224-0005-SP	KIT, SCREW, 6-19 x .375, PLASTITE, PH, PHD, 100/PK
2	808-0363-SP	KIT, LABEL, SODA, VALVE, COMPACT BG, 16/SHEET
	808-0364-SP	KIT, LABEL, WATER, VALVE, COMPACT BG, 16/SHEET
	808-0365-SP	KIT, LABEL, S1, VALVE, COMPACT BG, 16/SHEET
	808-0366-SP	KIT, LABEL, S2, VALVE, COMPACT BG, 16/SHEET
	808-0367-SP	KIT, LABEL, S3, VALVE, COMPACT BG, 16/SHEET
	808-0368-SP	KIT, LABEL, S4, VALVE, COMPACT BG, 16/SHEET
	808-0369-SP	KIT, LABEL, S5, VALVE, COMPACT BG, 16/SHEET
	808-0370-SP	KIT, LABEL, S6, VALVE, COMPACT BG, 16/SHEET
	808-0371-SP	KIT, LABEL, S7, VALVE, COMPACT BG, 16/SHEET
	808-0372-SP	KIT, LABEL, S8, VALVE, COMPACT BG, 16/SHEET
	808-0373-SP	KIT, LABEL, S9, VALVE, COMPACT BG, 16/SHEET
	808-0374-SP	KIT, LABEL, S10, VALVE, COMPACT BG, 16/SHEET
	808-0375-SP	KIT, LABEL, S11, VALVE, COMPACT BG, 16/SHEET
808-0376-SP	KIT, LABEL, S12, VALVE, COMPACT BG, 16/SHEET	
3	208-5111-SP	KIT, O-RING, 2-111, EPDM, 100/PK
4	208-5107-SP	KIT, O-RING, 2-107, EPDM, 100/PK
5	265-0759-SP	KIT, RETAINER, COMPACT, CLIP, 1/4" FITTING, 50/PK
6	208-5014-SP	KIT, O-RING, 2-014, EPDM, 100/PK
7	639-0060-SP	VALVE ASSY, FC, LONG-OUTLET, SYRUP, COMPACT BG
	639-0061-SP	VALVE ASSY, FC, SHORT-OUTLET, SYRUP, COMPACT BG
	639-0062-SP	VALVE ASSY, FC, SODA, COMPACT BG
	639-0063-SP	VALVE ASSY, FC, WATER, COMPACT BG
	639-0064-SP	VALVE ASSY, FC, LONG-OUT, DIET, COMPACT BG
8	265-0771	HOUSING, VALVES, 8/10B, COMPACT BG
	265-0772	HOUSING, VALVES, 12/14B, COMPACT BG
9	265-0762	PLATE, MOUNTING, 8/10B, W/INSERTS, COMPACT BG
	265-0766	PLATE, MOUNTING, 12/14B, W/INSERTS, COMPACT BG
10	224-0020-SP	KIT, SCREW, 8-16 x .250, PLASTITE, PH, PHD, 100/PK
11	808-0361-SP	KIT, LABEL, HOUSING LAYOUT, 8/10B, COMPACT BG, 4/PK
	808-0384-SP	KIT, LABEL, HOUSING LAYOUT, 12/14B, COMPACT BG, 4/PK
12	625-0067-SP	KIT, FITTING ASSY, 1/4 BARB x 1.25"L, W/FLANGE, 25/PK
13	208-5010-SP	KIT, O-RING, 2-010, EPDM, 100/PK
14	208-5108-SP	KIT, O-RING, 2-108, EPDM, 100/PK

# MECHANICAL MODULE ASSEMBLY

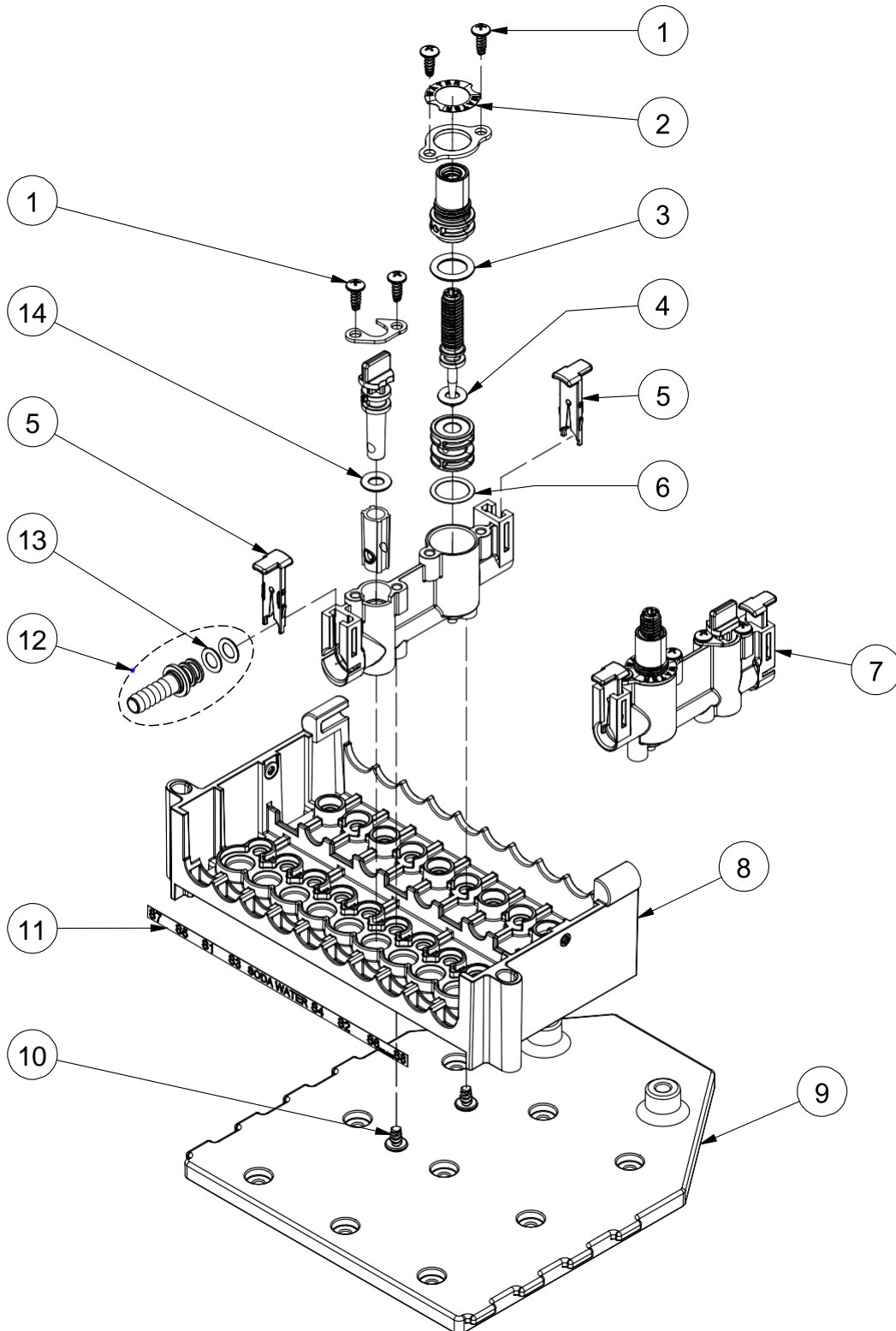

# MECHANICAL MODULE ASSEMBLY

<b>BARGUN MECHANICAL MODULE PARTS LIST</b>		
<b>ITEM</b>	<b>TAPRITE PN</b>	<b>DESCRIPTION</b>
1	224-0005-SP	KIT, SCREW, 6-19 x .375, PLASTITE, PH, PHD, 100/PK
2	808-0363-SP	KIT, LABEL, SODA, VALVE, COMPACT BG, 16/SHEET
	808-0364-SP	KIT, LABEL, WATER, VALVE, COMPACT BG, 16/SHEET
	808-0365-SP	KIT, LABEL, S1, VALVE, COMPACT BG, 16/SHEET
	808-0366-SP	KIT, LABEL, S2, VALVE, COMPACT BG, 16/SHEET
	808-0367-SP	KIT, LABEL, S3, VALVE, COMPACT BG, 16/SHEET
	808-0368-SP	KIT, LABEL, S4, VALVE, COMPACT BG, 16/SHEET
	808-0369-SP	KIT, LABEL, S5, VALVE, COMPACT BG, 16/SHEET
	808-0370-SP	KIT, LABEL, S6, VALVE, COMPACT BG, 16/SHEET
	808-0371-SP	KIT, LABEL, S7, VALVE, COMPACT BG, 16/SHEET
	808-0372-SP	KIT, LABEL, S8, VALVE, COMPACT BG, 16/SHEET
	808-0373-SP	KIT, LABEL, S9, VALVE, COMPACT BG, 16/SHEET
	808-0374-SP	KIT, LABEL, S10, VALVE, COMPACT BG, 16/SHEET
	808-0375-SP	KIT, LABEL, S11, VALVE, COMPACT BG, 16/SHEET
	808-0376-SP	KIT, LABEL, S12, VALVE, COMPACT BG, 16/SHEET
3	208-5111-SP	KIT, O-RING, 2-111, EPDM, 100/PK
4	208-5107-SP	KIT, O-RING, 2-107, EPDM, 100/PK
5	265-0759-SP	KIT, RETAINER, COMPACT, CLIP, 1/4" FITTING, 50/PK
6	208-5014-SP	KIT, O-RING, 2-014, EPDM, 100/PK
7	639-0065-SP	VALVE ASSY, MC, LONG-OUTLET, COMPACT BG
	639-0066-SP	VALVE ASSY, MC, SHORT-OUTLET, COMPACT BG
	639-0068-SP	VALVE ASSY, MECHANICAL, WATER, COMPACT BG
	639-0069-SP	VALVE ASSY, MECHANICAL, SODA, COMPACT BG
8	265-0771	HOUSING, VALVES, 8/10B, COMPACT BG
	265-0772	HOUSING, VALVES, 12/14B, COMPACT BG
9	265-0762	PLATE, MOUNTING, 8/10B, W/INSERTS, COMPACT BG
	265-0766	PLATE, MOUNTING, 12/14B, W/INSERTS, COMPACT BG
10	224-0020-SP	KIT, SCREW, 8-16 x .250, PLASTITE, PH, PHD, 100/PK
11	808-0361-SP	KIT, LABEL, HOUSING LAYOUT, 8/10B, COMPACT BG, 4/PK
	808-0384-SP	KIT, LABEL, HOUSING LAYOUT, 12/14B, COMPACT BG, 4/PK
12	625-0067-SP	KIT, FITTING ASSY, 1/4 BARB x 1.25"L, W/FLANGE, 25/PK
13	208-5010-SP	KIT, O-RING, 2-010, EPDM, 100/PK
14	208-5108-SP	KIT, O-RING, 2-108, EPDM, 100/PK

# MOUNTING PLATE SCREW PLACEMENT

6/8/10 BUTTON  
MOUNTING PLATE  
5 MOUNTING SCREWS

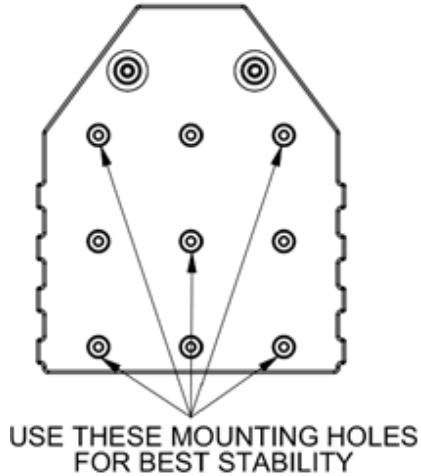

12/14 BUTTON  
MOUNTING PLATE  
6 MOUNTING SCREWS

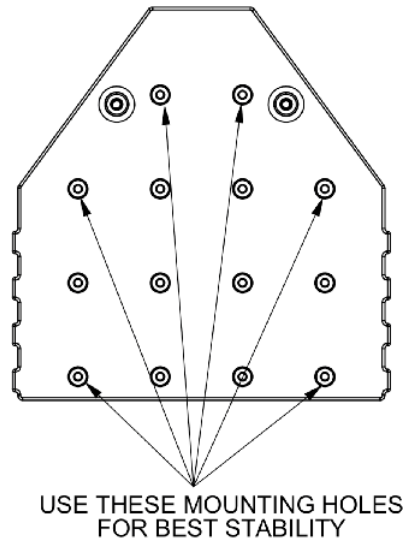

PATENT PENDING

## PATENT & PATENT PENDING NUMBERS

### UNITED STATES

7,658,006 8,109,413  
8,123,079 8,336,736  
8,387,829 8,418,888  
8,479,954 8,770,442  
8,807,395 8,814,003  
9,840,406 D697,753  
D717,590 D717,591  
D717,592 D717,593  
D786,616 D758,795

### UNITED KINGDOM

GB2468792 GB2474741  
GB2476347 GB2480531  
GB2480532

### AUSTRALIA

346264, 346389,  
AU201912368S

### MEXICO

41390, 317084, 31399

### EUROPE

2300353, 2336076,  
002159194, RCD NO.  
006408092-0001

# NEW BAR GUN PART NUMBER FORMAT

Bar Gun part numbers are formatted to capture all relevant information about a product so that it can be tracked for manufacturing, sale, troubleshooting and warranty purposes. As of 01/01/19, the format for the Bar Gun part number will be as follows:

The legacy part number will still be referenced in your order confirmation, packing lists, and invoices.

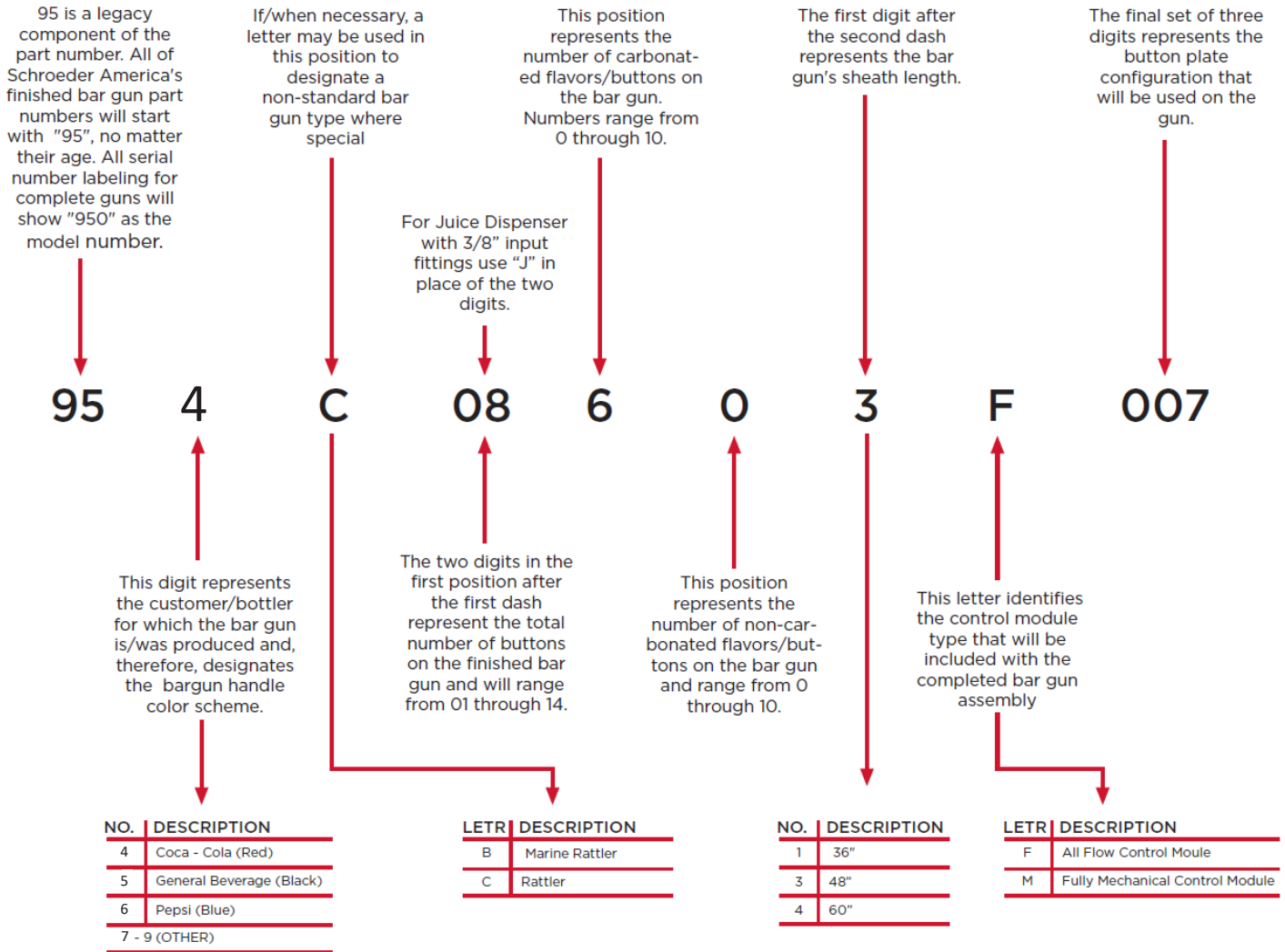

954C - 0860 - 3F007 represents a Red, Captive O-Ring Rattler Bar Dispenser with 8 Buttons. 6 buttons are for carbonated flavors and 0 buttons are for non-carbonated flavors. The unit has a 48" sheath and an all flow control module assembly. It uses button plate configuration 007. (Old PN 950-08600-1-01-48-007)



# APPENDIX

## SERVICING PLUNGER O-RINGS IN PREVIOUS VERSION HANDLES

In order to complete this action, Technicians will need:

- ✦ 316-0028-SP – O-ring Insertion and Extraction Tool (also found in 675-0209 Rattler Service Kit)
- ✦ 208-4003-SP – 208-003, Blue VITON XP41 O-Rings (also found in 675-0209 Rattler Service Kit)
- ✦ Phillips Head and Flat Head Screwdrivers
- ✦ Foodgrade Lubricant

To replace the O-Rings:

Use the screwdriver to remove the 6-32 x 3/8" screws which hold the bottom plate in place. Units which have not been opened previously may have one screw covered by the "CAUTION Overtightening Causes Damage" sticker. Pry away the plate to expose the plunger assemblies for removal. Keep the plunger springs attached to the bottom plate to ease reinstallation.



Use the O-ring Insertion and Extraction Tool to remove the plunger assemblies and the black O-rings. These parts may need to be removed separately. Use the barbed end of the tool when removing the components.



Apply a small amount of lubricant to the blue O-rings in preparation for placement. Too much lubricant can cause sticking and further leaks. Using the post end of the O-ring tool, insert the new O-ring fully into the channel. A small "pop" should be felt when the O-ring is seated.

View the O-rings from the side of the handle to see that they are fully in place. While observing, actuate the buttons on all replaced positions to check for "spring back" and to confirm that the O-rings are seated. If the O-rings move out of place or the buttons do not return to their original position, remove and reposition the O-rings until proper seating is achieved.

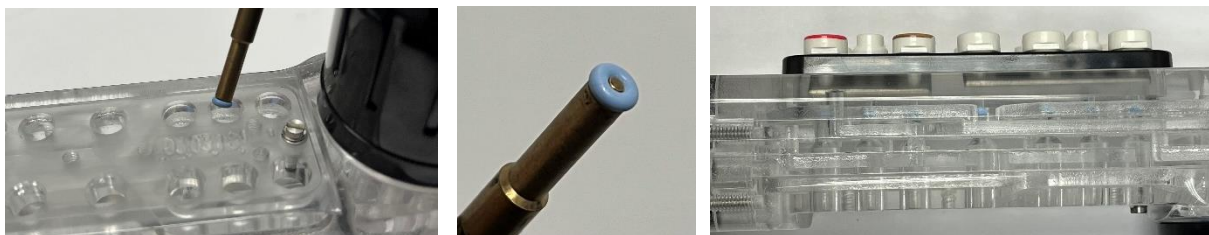

Reinstall the plunger assemblies and the bottom plate, taking care not to bend the plunger springs. Use the screwdriver to resecure the plate without overtightening.

